

MSI-8004HD

RF Indicator

Technical Manual



RICE LAKE[®]
WEIGHING SYSTEMS

© Rice Lake Weighing Systems. All rights reserved.

Rice Lake Weighing Systems® is a registered trademark of
Rice Lake Weighing Systems.

All other brand or product names within this publication are trademarks or
registered trademarks of their respective companies.

All information contained within this publication is, to the best of our knowledge, complete and
accurate at the time of publication. Rice Lake Weighing Systems reserves the right to make
changes to the technology, features, specifications and design of the equipment without notice.

The most current version of this publication, software, firmware and all other product
updates can be found on our website:

www.ricelake.com

Revision History

This section tracks and describes the current and previous manual revisions for awareness of major updates and when the updates took place.

Revision	Date	Description
B	June 3, 2024	Revision history established <ul style="list-style-type: none"> • Rugged Remote information added • Radio compliance information added • Real-time-clock for time and date support added • Dual channel analog output support added • Gravity compensation added • I/O options added • Layout and enclosure updated
C	April xx, 2025	Added Analog Output information

Table i. Revision Letter History



Technical training seminars are available through Rice Lake Weighing Systems. Course descriptions and dates can be viewed at www.ricelake.com/training or obtained by calling 715-234-9171 and asking for the training department.

Contents

1.0	Introduction	7
1.1	Features	7
1.2	FCC Compliance	7
1.3	Disposal	7
1.4	Safety	8
1.5	Front Panel Description	9
1.5.1	Keypad Functions	9
1.5.2	Annunciator Functions	10
2.0	Installation	11
2.1	Unpacking	11
2.2	Getting Started	11
2.3	Mounting the MSI-8004HD	11
2.4	Opening the Enclosure	12
2.5	Wiring/Connections	13
2.5.1	Connect Load Sensor	13
2.5.2	Power Supply	14
2.5.3	Analog Output Connection	15
2.6	Radio Module Replacement	16
2.7	ScaleCore Board Replacement	17
2.8	Antenna Replacement	17
2.9	Tilt Stand	18
2.10	Battery Option	19
2.10.1	Battery Life	19
2.10.2	Install Battery Option	20
2.10.3	Replace Battery	21
2.11	Parts Illustrations	22
2.11.1	MSI-8004HD Generation 1 Indicator	22
2.11.2	MSI-8004HD Generation 2 Indicator Parts	24
2.11.3	Tilt Stand	26
2.11.4	Battery Option	27
3.0	Operation	28
3.1	Power	28
3.2	Zero	28
3.3	Tare	29
3.3.1	View Tare	29
3.3.2	Clear Tare	29
3.4	Print	29
3.5	Function Keys	29
3.5.1	Test	30
3.5.2	Total	30
3.5.3	View Total	30
3.5.4	Net / Gross	31
3.5.5	Peak Hold	31
3.5.6	Units	31
3.5.7	High Resolution Test Mode	31



Rice Lake continually offers web-based video training on a growing selection of product-related topics at no cost. Visit www.ricelake.com/webinars

3.5.8	Channel Display	31
3.5.9	Add Load	31
4.0	Setup	32
4.1	Setup Navigation	32
4.2	Setup Menu	32
4.3	Function Keys	34
4.4	Auto-Off	34
4.5	Sleep	35
4.6	Display Brightness	35
4.7	Display Color	36
4.8	Setpoints	36
4.9	Output	38
4.10	Total Mode	38
4.11	Filter	39
4.12	Unit	40
5.0	Calibration	41
5.1	Calibration Switch	41
5.2	Standard Calibration	42
5.3	Initial Calibration	43
5.4	Guidelines for Capacity and Resolution	44
5.4.1	Capacity	44
5.4.2	Resolution	44
5.5	C-Cal Calibration	45
5.6	Calibration Setup Menu	46
5.6.1	Legal Weighing Standard Menu	46
5.6.2	Gravity Compensation	47
5.6.3	Auto Zero Maintenance	48
6.0	Communications	50
6.1	Communications Menu	50
6.2	Printer Setup	51
6.2.1	Control Modes	51
6.2.2	Standard Print Strings	52
6.2.3	Printer Output Setup	53
6.2.4	Custom Print Formatters	54
6.3	RF Network Setup	54
6.4	Setup Multiple Sensor Network	56
6.4.1	Set the Total Number of Load Sensors	56
6.4.2	Load Totaling Settings	57
6.4.3	Scan Weight Inputs	57
6.5	Zero and Tare in Multiple Load Pin Systems	57
6.5.1	Using the Tare Function	57
6.6	Real Time Clock	58
6.7	Communications Port Hardware	59
6.8	Relays	61
6.8.1	Relay Options	61



Technical training seminars are available through Rice Lake Weighing Systems. Course descriptions and dates can be viewed at www.ricelake.com/training or obtained by calling 715-234-9171 and asking for the training department.

6.8.2	Extended Relay Kit – Optional	62
6.9	Antenna Options	63
7.0	Optional Rugged Remote	65
7.1	Operation	65
7.1.1	Power	66
7.1.2	Zero	66
7.1.3	Programmable Function Keys	66
7.2	Conflict and Jamming Considerations	66
8.0	Troubleshooting and Maintenance	67
8.1	Troubleshooting	67
8.2	Error Codes	68
8.3	Service Counters	68
8.4	Mechanical Dimensions	69
8.5	Firmware Update	70
8.6	Coin-Cell Battery Replacement	71
9.0	Specifications	72



Rice Lake continually offers web-based video training on a growing selection of product-related topics at no cost. Visit www.ricelake.com/webinars

1.0 Introduction

This manual is intended for use by qualified technicians responsible for setting up and operating the MSI-8004HD.



Manuals are available from Rice Lake Weighing Systems at www.ricelake.com/manuals

Warranty information is available at www.ricelake.com/warranties

1.1 Features

- IP66 for outdoor use
- Six, 1.5 in (38 mm), LED digits (red/green/orange)
- Selectable units for kg or lb
- Automatic or manual weight totalization
- Eight setpoints
- ScaleCore technology

1.2 FCC Compliance

United States

This equipment has been tested and found to comply with the limits for a Class A digital device, pursuant to Part 15 of the FCC Rules. These limits are designed to provide reasonable protection against harmful interference when the equipment is operated in a commercial environment. This equipment generates, uses and can radiate radio frequency energy and, if not installed and used in accordance with the instruction manual, may cause harmful interference to radio communications. Operation of this equipment in a residential area is likely to cause harmful interference in which case the user will be required to correct the interference at his own expense.

Canada

This digital apparatus does not exceed the Class A limits for radio noise emissions from digital apparatus set out in the Radio Interference Regulations of the Canadian Department of Communications.

Le présent appareil numérique n'émet pas de bruits radioélectriques dépassant les limites applicables aux appareils numériques de la Class A prescrites dans le Règlement sur le brouillage radioélectrique édicté par le ministère des Communications du Canada.

1.3 Disposal



Product Disposal

The product must be brought to appropriate separate waste collection centers at the end of its life cycle.

Proper separate collection to recycle the product helps prevent possible negative effects on the environment and to health, and promotes the recycling of the materials. Users who dispose of the product illegally shall face administrative sanctions as provided by law.

Battery Disposal

Dispose of batteries at appropriate waste collection centers at the end of their life cycle in accordance with local laws and regulations. Batteries and rechargeable batteries may contain harmful substances that should not be disposed of in household waste. Batteries may contain harmful substances including but not limited to: cadmium (Cd), lithium (Li), mercury (Hg) or lead (Pb). Users who dispose of batteries illegally shall face administrative sanctions as provided by law.



WARNING: Risk of fire and explosion. Do not burn, crush, disassemble or short-circuit lithium batteries.

1.4 Safety

Safety Definitions:



DANGER: Indicates an imminently hazardous situation that, if not avoided, will result in death or serious injury. Includes hazards that are exposed when guards are removed.



WARNING: Indicates a potentially hazardous situation that, if not avoided, could result in serious injury or death. Includes hazards that are exposed when guards are removed.



CAUTION: Indicates a potentially hazardous situation that, if not avoided, could result in minor or moderate injury.



IMPORTANT: Indicates information about procedures that, if not observed, could result in damage to equipment or corruption to and loss of data.

General Safety



Do not operate or work on this equipment unless this manual has been read and all instructions are understood. Failure to follow the instructions or heed the warnings could result in injury or death. Contact any Rice Lake Weighing Systems dealer for replacement manuals.



WARNING

Failure to heed could result in serious injury or death.

Do not allow minors (children) or inexperienced persons to operate this unit.

Do not stand near a load being lifted as it is a potential falling hazard. Keep a safe distance.

Do not use for purposes other than weight taking or dynamic load monitoring.

Do not use any load bearing component that is worn beyond five percent of the original dimension.

Do not use any associated lifting product if any of the load bearing components are cracked, deformed or show signs of fatigue.

Do not exceed the rated load limit of the associated scale/dynamometer unit, rigging element or the lifting structure.

Do not allow multi-point contact with the hook, shackle or lifting eye of the associated scale/Dynamometer unit.

Do not allow high torque on the scale/dynamometer unless it is specifically designed for high torque.

Do not make alterations or modifications to the unit or associated load bearing devices; any alterations void the warranty.

Do not remove or obscure warning labels.

There are no user serviceable parts within the MSI-8004HD. Any repairs must be performed by qualified service personnel only.

1.5 Front Panel Description

The MSI-8004HD front panel keys and annunciators are described in [Table 1-1](#) and [Table 1-2](#) on page 10.

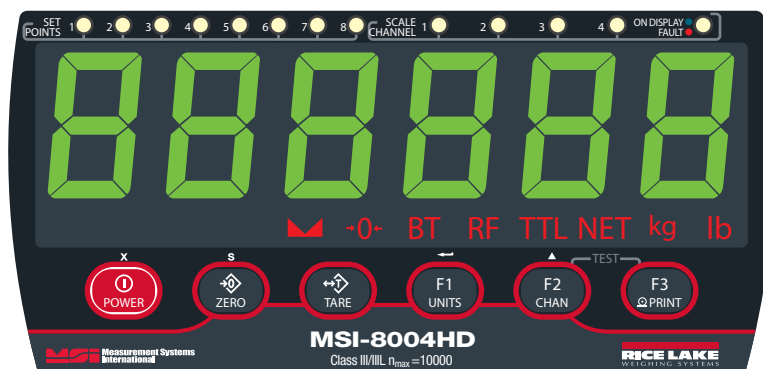

Figure 1-1. Front Panel

1.5.1 Keypad Functions

The functions of the push buttons vary based on the current MSI-8004HD mode.

Key		Weigh Mode	Setup Menu Navigation	Numeric Entry
	Power Key	Turns the MSI-8400HD On and Off	Exits setup without saving changes; <i>ERR</i> displays momentarily and unit enters <i>Weigh</i> mode	Enters decimal point to the left of the blinking digit
	Zero Key	Zeros out residual weight on the scale	Saves and drops back one menu level; At the root menu level the Zero key stores the changes and returns to Weigh mode <i>StorE</i> displays briefly	Steps back one digit to change or correct the digit to the left
	Tare Key	Removes the weight of containers, trucks or carriers and places the scale in the Net Weigh mode		
	Unit Key	Programmable to user selectable functions (Section 4.3 on page 34); This key is defaulted to the Unit function	Functions as the Enter/Select key	Confirms blinking digit and move to the digit to the right
	Chan Key	Programmable to user selectable functions (Section 4.3 on page 34); This key is defaulted to the Chan function	Functions as the Scroll key	Cycles blinking digit through numbers 0-9
	Print Key	Prompts print command	Press simultaneously to initiate a test of the unit	

Table 1-1. Key Functions

Example of numeric entry: Enter 2500 kg on a 5000 kg capacity scale.

- Press two times for the leftmost blinking digit, press to save two as the digit selection.
- Press five times for the next blinking digit, press to save five as the digit selection.
- Press to save zero as the next digit selection.
- Press to save zero as the next digit selection. *2500* displays.

1.5.2 Annunciator Functions

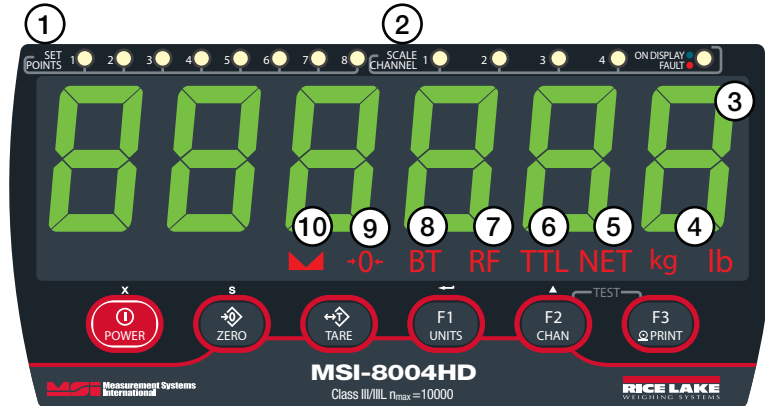

Figure 1-2. Front Panel

Item No.	Key	Description
1	Set Points	User programmable setpoints for overload warnings; they are green when set and flash red when tripped
2	Scale Channel	Blue LED indicates the channel on display; If red, a fault is detected
3	Display Digits	Includes six 1.5" (38 mm) sunlight visible LED's; Color - Red/Green/Orange
4	kg	Indicates load display is in kilograms
	lb	Indicates load display is in pounds
5	Net	RF linked device is in Net load mode; A tare weight is subtracted from the gross load
6	Total	RF linked device is displaying the total accumulated weight; A temporary display lasting less than 5 seconds
7	RF	Indicates an active radio communication link with a scale or indicator
8	Low Battery	Illuminates when approximately 10% of battery life remains, flashes when automatic shutdown is eminent
9	Center of Zero	Indicates that the scale/Dyna-Link is within 1/4 d of zero
10	Standstill	Load has settled within the motion window (usually $\pm 1d$); If off, the scale will not zero, tare or totalize

Table 1-2. Annunciator Functions

2.0 Installation

This section provides an overview of the MSI-8004HD installation instructions.

2.1 Unpacking

Remove the MSI-8004HD from the packaging and inspect for visible damage. If damaged occurred during shipping, notify Rice Lake Weighing Systems and the shipper immediately.

Retain original packaging when possible, in the event that it needs to be returned, it must be properly packed with sufficient packing materials.

2.2 Getting Started

The MSI-8004HD is often shipped pre-configured with a scale. If purchased separately, or to be used with a different system, the RF transceivers will have to be paired. Follow the RF Setup Procedure in [Section 6.3 on page 54](#).

The system automatically connects with the scale once the RF setup is complete. A site survey is recommended to identify the RF Link's operating range and usability. Position the scale at an average operational height, and try the link at various positions and distances. The range may vary by the rotation of the scale/Dyna-Link, as well as the site and installation variables.

2.3 Mounting the MSI-8004HD

The provided tilt stand can be used to mount the MSI-8004HD to a wall or counter top.

It can also be mounted directly to a wall or panel using bolts in the mounting holes of the unit.

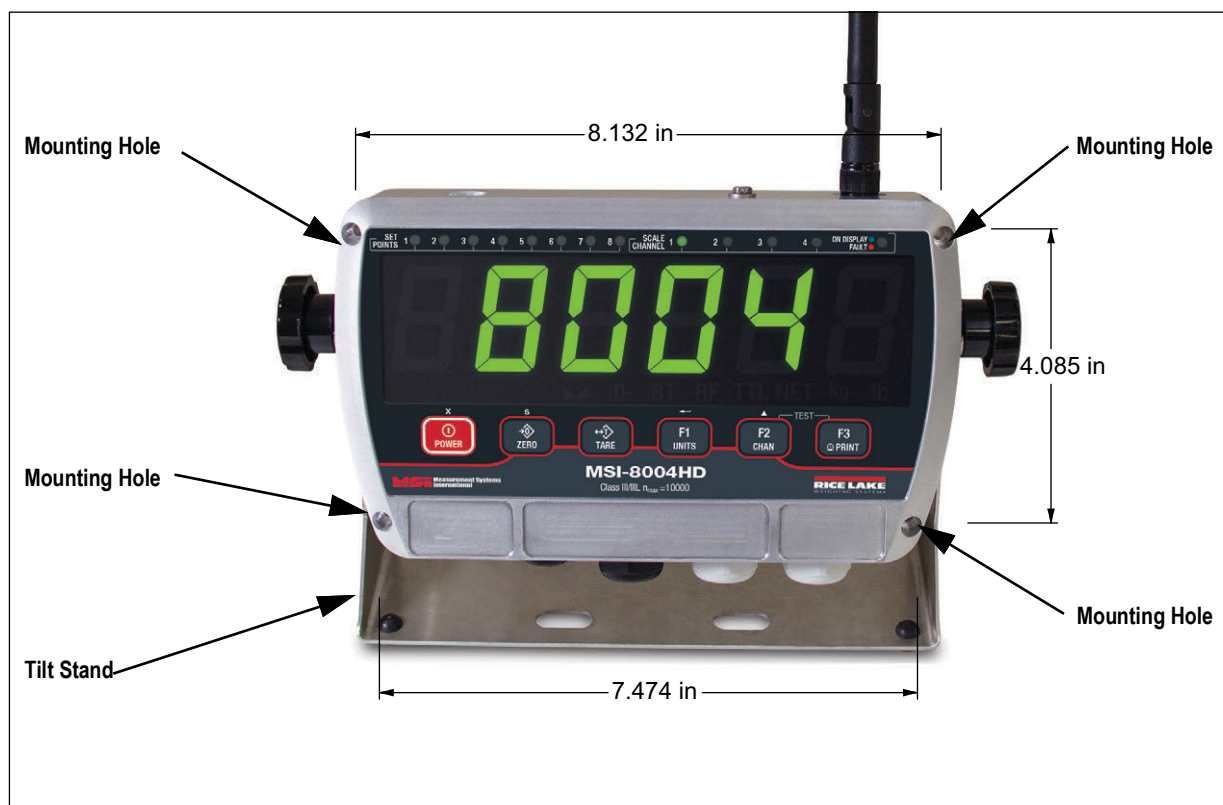

Figure 2-1. Mounting Hole Location with Dimensions

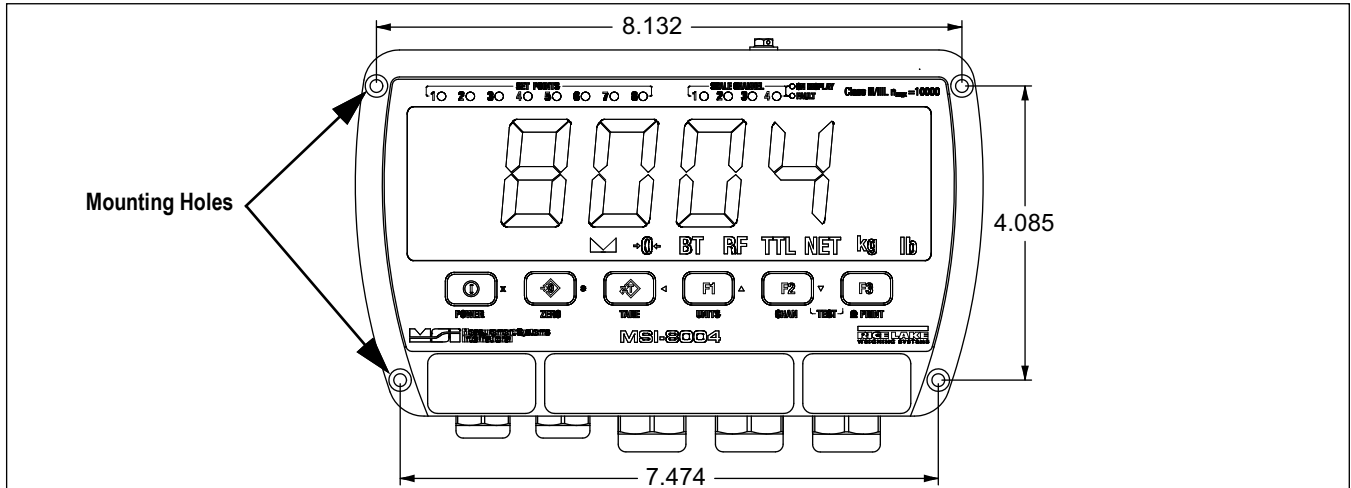

Figure 2-2. Mounting Hole Locations with Dimensions

2.4 Opening the Enclosure

The indicator enclosure must be opened to connect the load cell/sensor cables and other interface connections.



WARNING: Before opening the unit, ensure the power is disconnected.

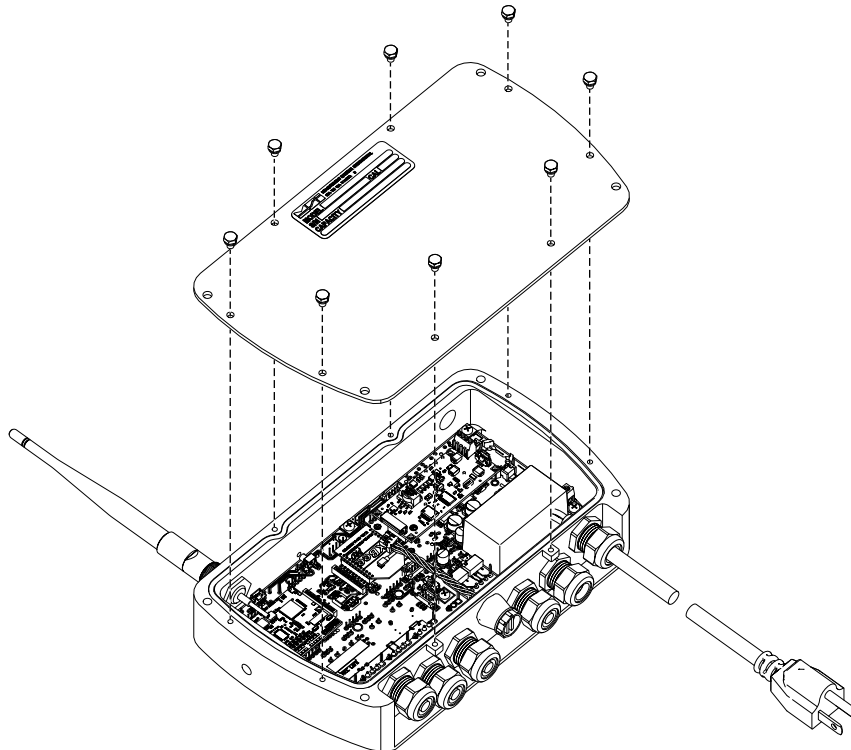



Figure 2-3. Open Enclosure

1. Place the indicator face down on an anti-static work mat.
2. Remove the screws securing the backplate to the enclosure. Retain for re-installation.
3. Remove the backplate to access the interior and set it aside.

2.5 Wiring/Connections

See [Section 6.7 on page 59](#) for wiring connections of the serial cable and printer.

 **WARNING:** Before opening the unit, ensure the power is disconnected.

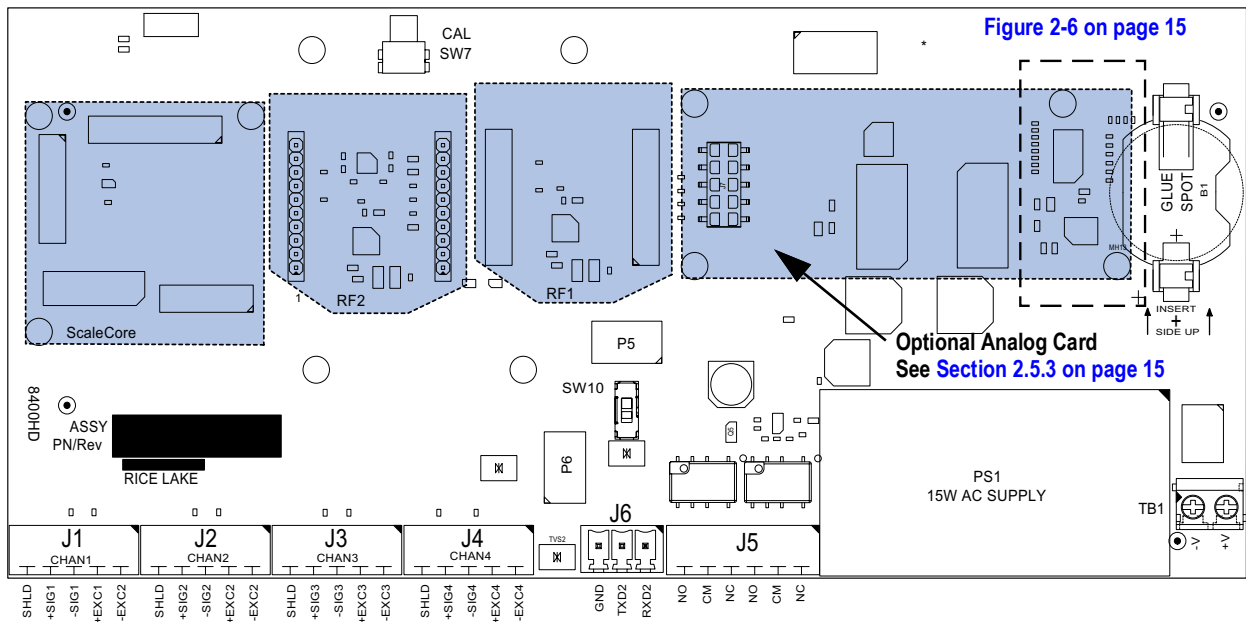

Figure 2-4. Connectors

2.5.1 Connect Load Sensor

1. Remove backplate ([Section 2.4 on page 12](#)).
2. Loosen the cable connectors and remove the pin.
3. If connecting four load sensors, insert the two hole insert into the cable connectors.
4. Run load sensor cables through the cable connectors into the indicator.
5. Loosen the screws in load sensor connector.
6. Insert stripped end of each wire into the holes of the connector.

 **NOTE:** Terminal Blocks can be removed from the terminal block headers for easier load cell cable installation.

7. Re-tighten screws to secure wires.
8. Align the back plate on the enclosure and secure with screws.

 **IMPORTANT:** The indicator must be calibrated once the load sensors have been connected ([Section 5.0 on page 41](#)).

2.5.2 Power Supply

Both AC and DC power supply are available for the MSI-8004HD.

 **WARNING:** Before opening the unit, ensure power is disconnected.

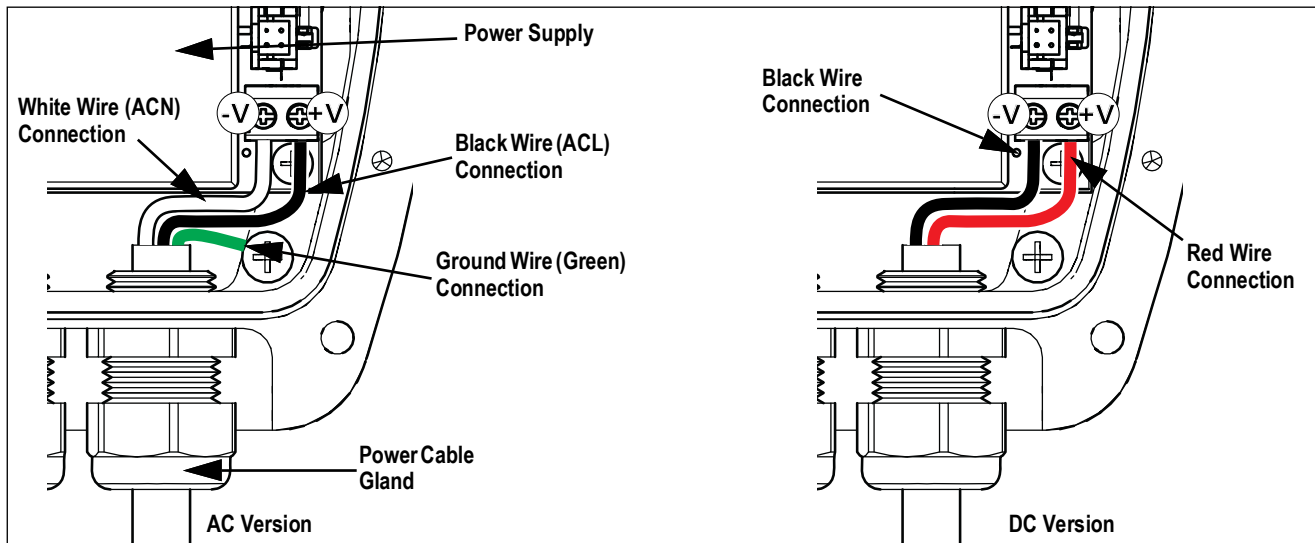

Figure 2-5. Power Supply

1. Remove backplate ([Section 2.4 on page 12](#)).
2. Loosen screws in the power wire connector to pull the wires from the connector.
3. Remove the screw securing the ground wire (AC Only).
4. Loosen the cable gland and pull the power cable from the enclosure.
5. Push new cable through the cable gland and reconnect wiring as shown in [Figure 2-5](#).
6. Ensure all connections are tight and reinstall the back plate.

2.5.3 Analog Output Connection

The Analog Output Option provides a means to connect the MSI-8004HD to analog inputs found on PLCs and other industrial equipment. The optional Analog Output board allows one or two channels of the MSI-8004HD to drive the Analog Outputs. See the ScaleCore Connect or ScaleCore Webserver Technical Manuals for more information on configuring analog output.

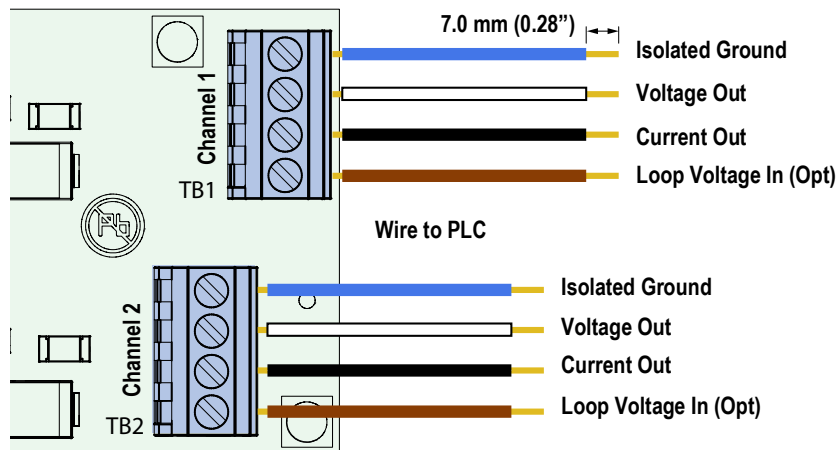

Figure 2-6. Analog Option Card

Wire to PLC

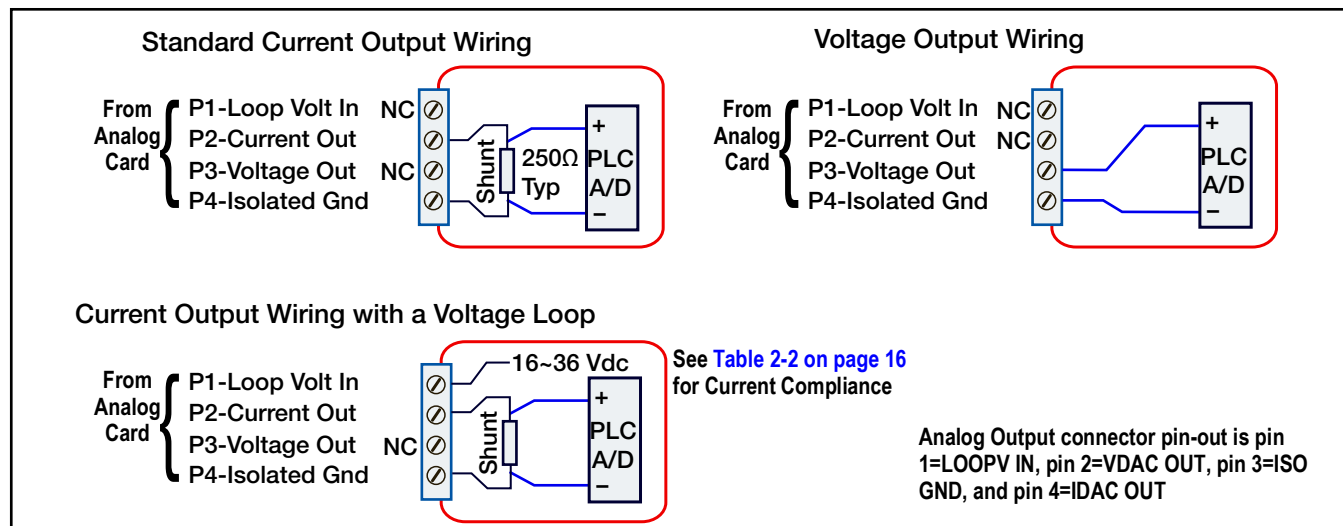

Figure 2-7. PLC Wiring

Pin #	Wire Color	Function	Comment
1	Brown	Loop Voltage In	Optional for increasing compliance. Input range: +16V to 36V max
2	Black	Current Out	Will drive 20mA into 625Ω without external boost voltage (Table 2-2)
3	White	Voltage Output	Specified for load resistance ≥1kΩ. Recommended load resistance: 100kΩ to minimize voltage drop due to wire resistance in connecting cable
4	Blue	Isolated Ground	Connection required for current and voltage output

Table 2-1. Analog Output Wiring

External Loop Voltage Input	20mA Output Max R _{wiring+} Rshunt	24mA Output Max R _{wiring+} Rshunt
None	625Ω	520Ω
18V	750Ω	625Ω
24V	1.05kΩ	875Ω
30V	1.35kΩ	1.125kΩ
36V	1.65kΩ	1.375kΩ

Table 2-2. Current Compliance Table

Connecting Analog Output Cable to the Analog Output Connector

The MSI-8004HD connects to a PLC or other industrial equipment through the analog output cable. Connect the wires of the analog output cable to the analog output channels in [Figure 2-6 on page 15](#).

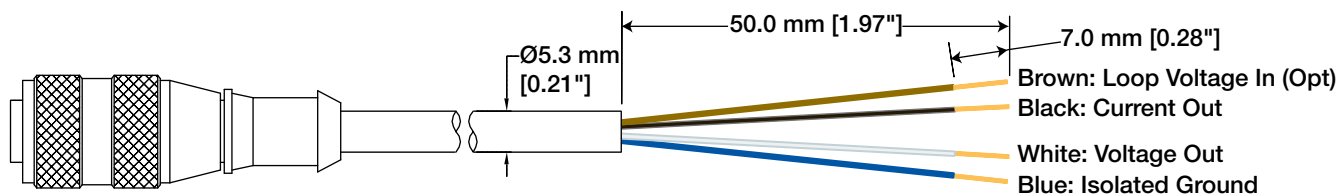

Figure 2-8. Analog Output Cable Wiring

2.6 Radio Module Replacement

The MSI-8004HD can have two radio modules installed at a time. RF1 is programmed to be used with the Rugged Remote. RF2 can be 802.15.4, Wi-Fi, or FHSS. If ordered with purchase of a system, radio modules will be installed and paired to the scale included in the order. To order separate or for more information Contact Rice Lake Weighing Systems or a local dealer.

1. Remove backplate ([Section 2.4 on page 12](#)).

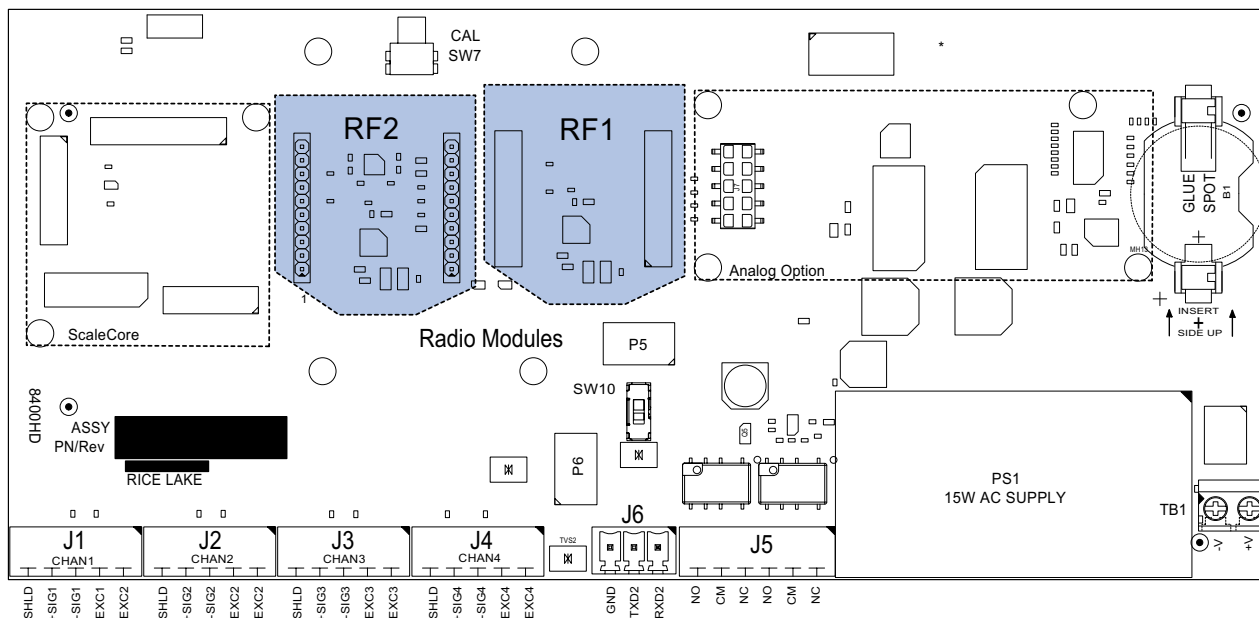

Figure 2-9. XBee Card Replacement Location

2. Disconnect the antenna wire from the XBee card.
3. Pull card up to remove from the CPU Board.
4. Align new card with the connection. Ensure it is in line with the correct holes.
5. Press card into place and reconnect the antenna wire.



NOTE: The matching card must be installed in the connected device. See the scale manual for instructions.

2.7 ScaleCore Board Replacement

1. Remove backplate (Section 2.4 on page 12).

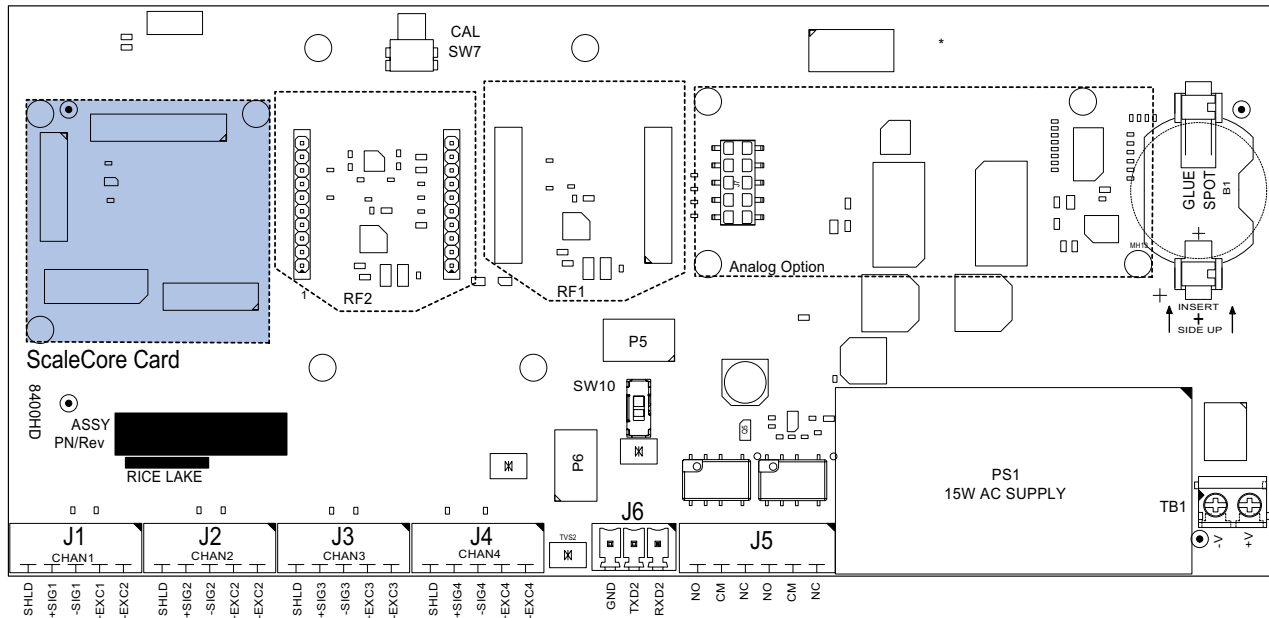

Figure 2-10. ScaleCore Board Replacement Location

2. Pull the ScaleCore card up to remove it.
3. Align the new card to the CPU board and standoffs.
4. Press firmly to secure the card in place.

2.8 Antenna Replacement

There are many antenna options available with the MSI-8004HD (Section 6.9 on page 63). This section contains instructions to replace the standard antenna. For other options, contact Rice Lake Weighing Systems or a local dealer.

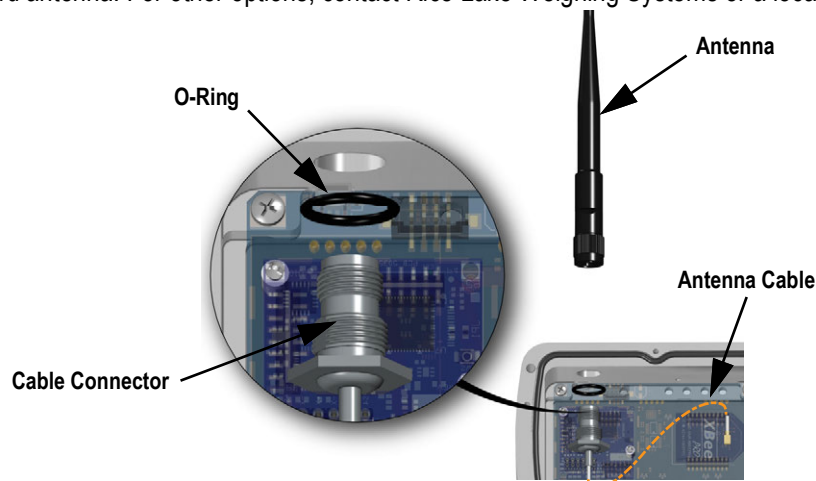

Figure 2-11. Replace Antenna

1. Remove backplate only if replacing the internal antenna cable (Section 2.4 on page 12).
2. Unscrew the antenna from the cable connector.
3. If replacing antenna cable, remove the connector and o-ring from the enclosure and disconnect from the radio module.
4. Install a new antenna or antenna cable, reverse the above steps.

2.9 Tilt Stand

For tilt stand installation, see the following information:



Figure 2-12. Install Tilt Stand

1. Place Loctite® on the end of the set screws and screw them into the hole on each side of the indicator.
2. Place a washer over each set screw.
3. Align the stand with the set screws on the indicator.
4. Place the remaining washers on the set screws on each side of the indicator.
5. Screw knobs onto set screws loosely.
6. Adjust tilt of indicator to desired position and tighten knobs.

2.10 Battery Option

The battery powered MSI-8004HD may be powered by a 5 VDC Li-ion rechargeable battery built into the included Tilt Stand Kit. This battery operates for up to 80 hours (depending on LED brightness setting) before requiring recharging. Charging time for a completely discharged battery is up to eight hours. A spare battery pack is recommended to keep the MSI-8004HD in continuous operation.



IMPORTANT: To obtain maximum service life from the batteries they should be stored between -4°F and 122°F (-20°C and $+50^{\circ}\text{C}$). Stored batteries should be recharged every three months.

2.10.1 Battery Life

The battery life of the MSI-8004HD depends on a number of factors:

- Brightness of the LED display and number of segments lit
- Amount of RF activity
- Age of the battery
- Condition of the SLA battery

In order to conserve battery life, the MSI-8004HD includes the following features.

- Automatic Off Mode – Senses no activity after a set amount of minutes and turns the scale off
- Sleep Mode – Dims the display after a set amount of minutes of no scale activity

The MSI-8004HD automatically turns off when the battery is discharged and requires recharging. Li-ion batteries benefit from frequent recharging and can be recharged when there is still available life.

Due to the maintenance discharge imposed on the battery by the MSI-8004HD electronics, do not store with the battery in the unit. Remove the battery if it will not be used for more than two weeks.



NOTE: Use the following note for battery charging, storage and disposal:

- For continuous indicator use, a fully charged spare battery is recommended
- Replace the drained battery as close as possible to the low battery warning
- Batteries that have not been deep discharged should withstand 500 to 1500 charging cycles
- Low battery warning annunciator indicates two to four hours of use prior to indicator powering off
- For long term storage, remove the battery to prevent deep discharge
- Recycle battery at an authorized recycling center when the average life drops to 20 hours or less

2.10.2 Install Battery Option

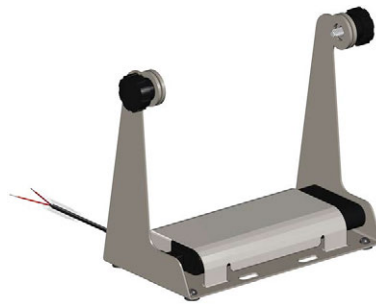

Figure 2-13. Tilt Stand with Battery Option

1. Power off the indicator.
2. Remove indicator from the tilt stand by removing the knobs, washers and screws.
3. Install the indicator on the battery option tilt stand (Figure 2.9 on page 18).
4. Remove the USB cable to the battery, if needed.
5. Remove the back plate of the indicator (Section 2.4 on page 12).

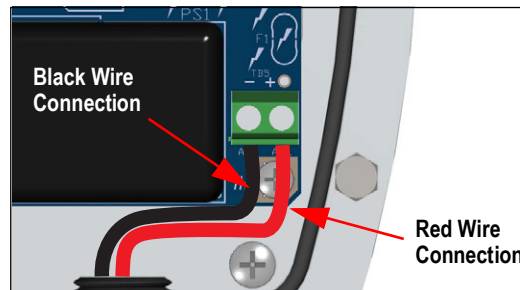

Figure 2-14. USB Cable to CPU Board

6. Connect the USB cable from the battery to the CPU board.
7. Replace the back plate.
8. Plug the USB cable to the battery.
9. Power on the indicator.

2.10.3 Replace Battery

1. Power off the indicator.

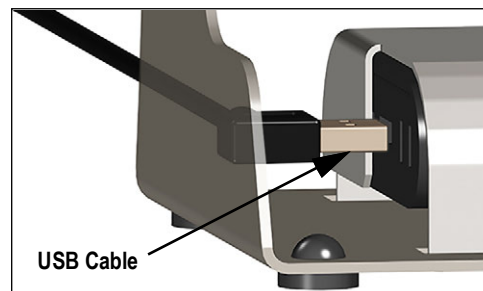

Figure 2-15. Disconnect USB Cable

2. Remove the cable from the USB plug in the battery.
3. Remove indicator from the tilt stand by removing the knobs, washers and screws.

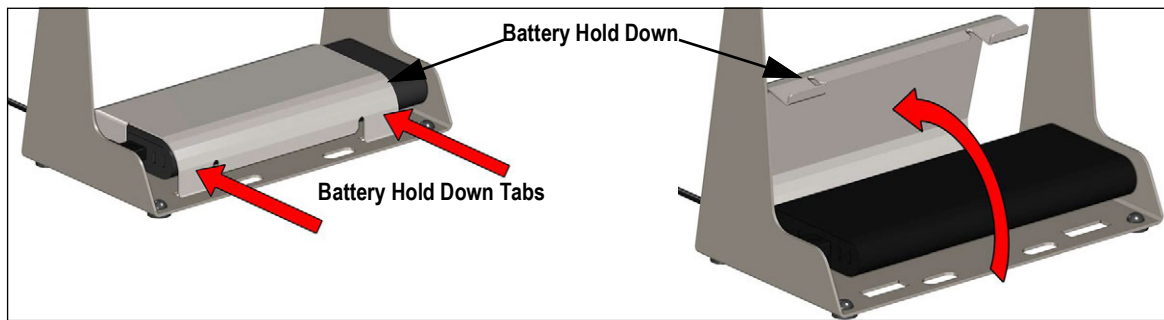

Figure 2-16. Remove Battery Hold Down

4. Press on the battery hold down tabs and push it up to release it from the tilt stand.
5. Remove the battery.
6. Place a charged battery on the tilt stand, ensuring the end with connections is facing the correct direction.
7. Put the tabs from the battery hold down into the slots on one side of the tilt stand and rotate it down over the battery.
8. Press the tabs it and insert into holes in the tilt stand.
9. Reinstall the indicator ([Section 2.9 on page 18](#)).
10. Connect the USB cable to the battery.
11. Power on the indicator.

2.11 Parts Illustrations

Refer to the following illustrations and list for replacement parts.

2.11.1 MSI-8004HD Generation 1 Indicator

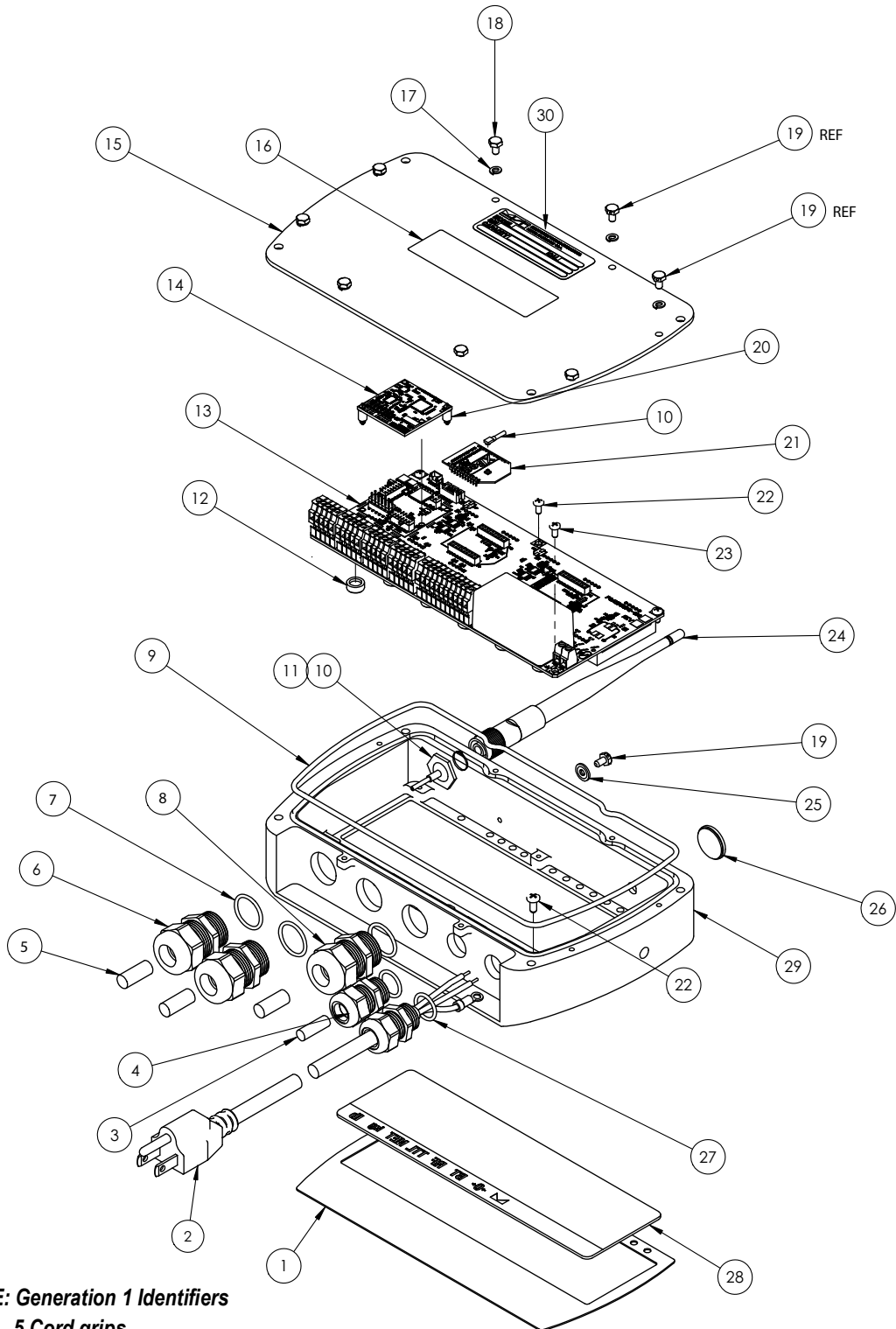

NOTE: Generation 1 Identifiers

- 5 Cord grips
- Blue PCA Board
- Blue Front Overlay Text

Figure 2-17. MSI-8004HD Generation 1 Indicator Parts Illustration

Item No.	Part No.	Description	Qty.
1	178180	Overlay, standard	1
2	160518	Power cord AC in	1
3	141991	Pin round acetal 0.25 in diameter	1
4	141593	Conn feed through liquid tight dome PG9	1
5	142554	Pin round acetal 0.312 in diameter	3
6	177368	Conn feed through liquid tight dome PG13 Gray	2
7	177366	O-ring, PG13, Buna-N	3
8	177364	Conn feed through liquid tight dome PG13 Black	1
9	153110	O-ring 7-1/4 x .103	1
10	152051	Cable assembly RF coax TNC bulkhead to Xbee 3.50 long	1
11	153793	O-ring 1/2 Id x .070 nitrile	1
12	177362	Key cap, SMS switches	6
13	Varies	PCA 8004 indicator green/red	1
14	153431	PCA ScaleCore3 4-channel	1
15	152034	Cover fixed mount 8000	1
16	159855	Overlay TranSend FCC	1
17	146538	Washer split lock stainless steel #6	8
18	146022	Bolt hex head 6-32 x 1/4 cap stainless steel	6
19	143271	Screw mach hex head HD DR HD SS 6-32 1/4 w/ 0.045 hole ID	3
20	144929	Spacer miniature dual locking 6 mm long	2
21	144773	Radio module Xbee-pro	1
22	144537	Screw LKG PCH pan head 6-32	1
	142233	Screw, pan head, locking, 4-40 x 3/16, Phillips, stainless steel	5
23	146543	Screw pan head 4-40 x 1/4 nylon	1
24	143283	Antenna 2.4 GHz	1
25	143272	Washer seal #6 steel	1
26	158438	Plug diameter 0.750 in with adhesive	2
27	177363	O-ring, PG9, Buna-N	2
28	177579	LED filter med grey	1
29	176517	Enclosure machined 8004	1
30	178637	Serial Number Tag, TTL 2.75 in x 1.00 in Custom Logos and Text Box, Imprintable	1

Table 2-3. MSI-8004HD Generation 1 Indicator Parts List

2.11.2 MSI-8004HD Generation 2 Indicator Parts

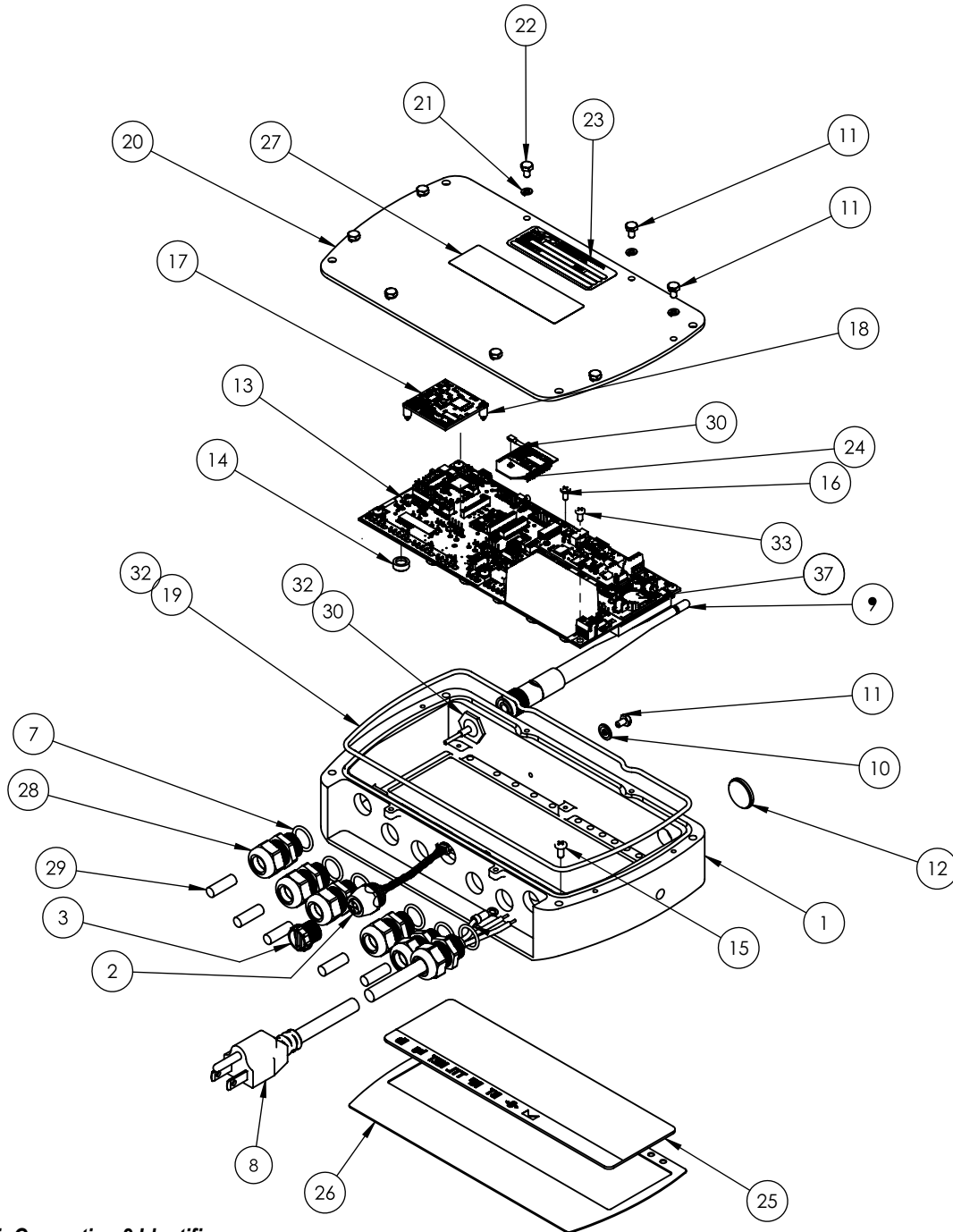

NOTE: Generation 2 Identifiers

- 6 Cord grips
- Red PCA Board
- Red Front Overlay Text

Figure 2-18. MSI-8004HD Generation 2 Indicator Parts Illustration

Item No.	Part No.	Description	Qty.
1	220573	Enclosure Machine 8004HD Gen2	1
2	139449	Cable Assy, Comm Serial Data RS-232	1
3	143352	Conn Closure Cap IP68 Male	1
7	177363	O-Ring, PG9, Buna-N	6
8	See Note*	Power Cord	1
9	143283	Antenna 2.4 GHz Articulated w/TNC Connector	1
10	143272	Washer Seal #6 Steel Zinc Pltd	1
11	143271	Screw Mach Hex HD DR HD SS 6-32 1/4 with 0.045 hole ID	3
12	158438	Plug Dia .750 w/ Adhesive .10 Thick	1
13	See Note*	PCA 8004HD Indicator	1
14	177362	Key Cap, SMS Switches .423 Switch Height, Blue	6
15	144537	Screw Lkg PCH PH 6-32 x 1/4 Phil SS	1
16	142233	Screw, Machine, 4-40x 3/16, Pan head, Phillips Drive, Nylon Patch, SST	5
17	See Note*	PCA Scalecore3	1
18	144929	Spacer Miniatur Dual Locking 6 mm Long	2
19	153110	O-Ring 7-1/4 x .103 Nitrile 70 As568-168	1
20	152034	Cover Fixed Mount	1
21	146538	Washer Split Lock SS #6	8
22	146022	Bolt HH 6-32 x 1/4 Cap SS Trimmed	6
23	148637	Serial Number Tag, TTL 2.75 x 1.00 custom logos and text box, imprintable	1
24	144773	Radio Module XBEE-Pro 802.15.4 U.FL Connect	1
25	177579	LED Filter Md Grey	1
26	221264	Overlay, MSI-8004HD, Gen2	1
27	159855	Overlay TranSend FCC	1
28	141593	Conn Feed Thru Liquid Tight Dome PG9 .16-.31 Cable Dia w/Nut - Assembled	5
29	141991	Pin Round Acetal .25 Dia .75 LG	5
30	152051	Cable Assy, RF Coax TNC Bulkhead to XBEE 3.50 Long	1
32	142039	Silicone Oil 1000 CS Viscosity	
33	146543	Screw PH 4-40 x 1/4 Nylon Slot	1
36	155173	Option Kit Tilt Stand	1
37	71408	CR2032 Battery	1

* Part number varies per configuration

Table 2-4. MSI-8004HD Generation 2 Indicator Parts List

2.11.3 Tilt Stand

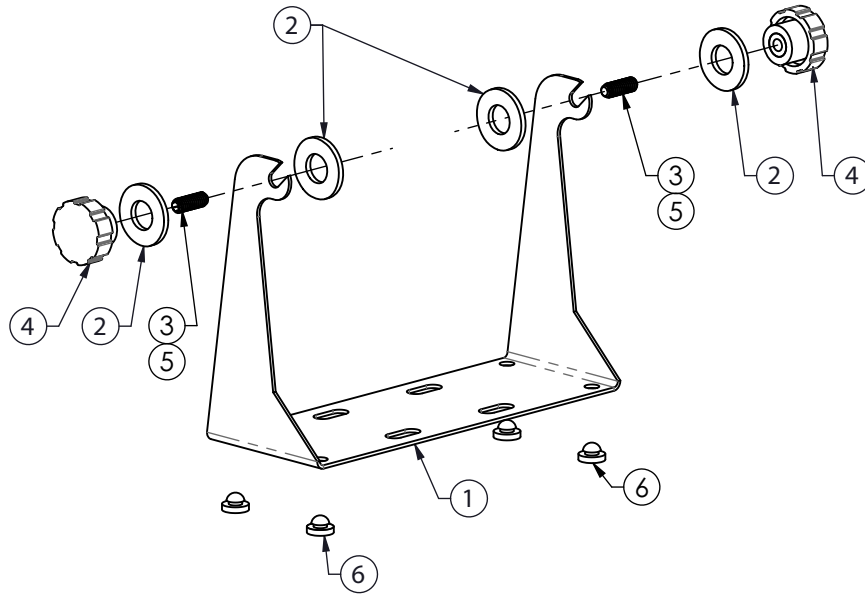

Figure 2-19. Tilt Stand Assembly (155173)

Item No.	Part No.	Description	Qty.
1	155172	Tilt Stand	1
2	146200	Washer Flat 5/8 Plated	4
3	155192	Screw Set Allen DR CP SS 5/16-18 x 7/8 LG	2
4	143879	Knob Fluted 5/16-18 Internal Thread	2
5	142031	Adhesive Loctite® 271-21 Red 0.34 oz	2
6	143224	Rubber Feet	4

Table 2-5. Tilt Stand Parts List

2.11.4 Battery Option

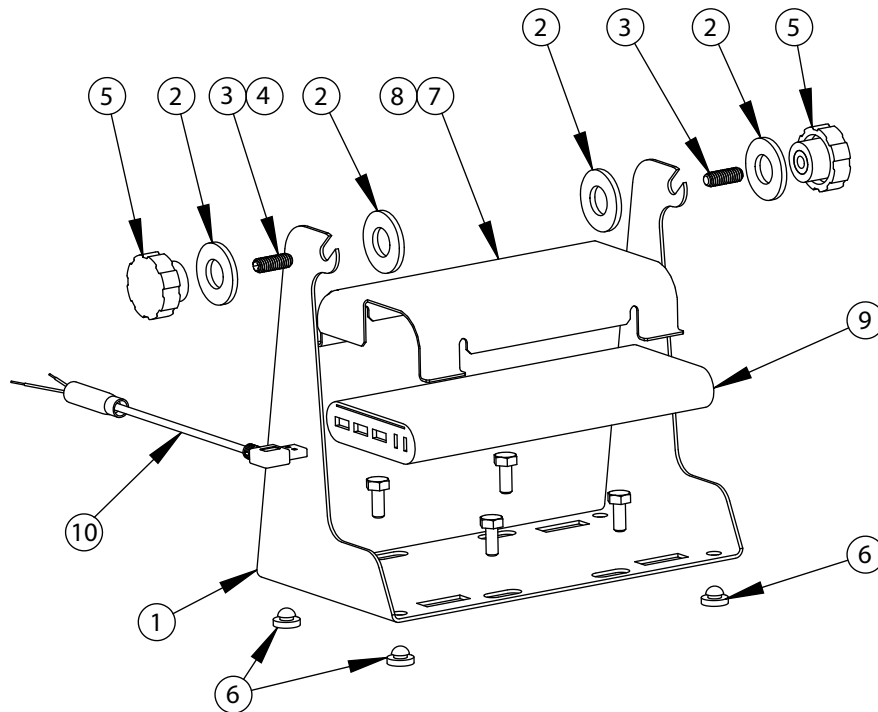

Figure 2-20. Battery Option Parts Illustration

Item No.	Part No.	Description	Qty.
1	155172	Tilt Stand	1
2	146200	Washer Flat 5/8 Plated	4
3	155192	Screw Set Allen DR CP SS 5/16-18 x 7/8 LG	2
4	142031	Adhesive Loctite® 271-21 Red 0.34 oz	AR
5	143879	Knob Fluted 5/16-18 Internal Thread	2
6	143224	Rubber Feet	4
7	183070	Battery Hold Down 8004	1
8	148599	Pad Battery Side	4
9	184043	Battery, 5 V Li-ion, USB	1
10	183494	Cable Assembly USB Power	1

Table 2-6. Battery Option Parts List

3.0 Operation

This section covers the basic operation of the MSI-8004HD.

3.1 Power

The power key turns the MSI-8004HD power on. While in Weigh mode, it also turns the power off.

Press  to turn on the power. The following sequence displays:

1. All LED segments light in orange at full brightness as a display test.
2. *SOFt* displays, followed by the software version number.
3. *SEAd* displays, followed by the legal-for-trade weighing standard.
4. *bAtE* displays, followed by the battery volts.
5. *dRtE* displays, followed by the date in “YY.MM.DD” format.
6. *t iE* displays, followed by the time in 24 hour format.
7. *d. tESt* displays, followed by the display counting from 00000 to 99999.
8. *[-]CAL* displays, followed by the C-CAL value.
9. MSI-8004HD enters Weigh mode.

While in Weigh mode, press  to turn off the power.



IMPORTANT: *The scale has a maintenance battery drain. Always remove the battery if the scale will be off for an extended period of time. Leaving a discharged battery in the scale can result in a deep discharged battery which will shorten its service life.*

3.2 Zero

The zero key sets the zero reading of the scale.

Press  to remove small deviations in zero when the scale is unloaded. For zeroing (taring) package or pallet weights, see [Section 3.3](#). The zero key can be used in **GROSS** or **NET** mode.



NOTE: *The backup memory in the unit stores the zero reading and retains it even if the power fails.*

Zeroing while in NET mode will zero the GROSS weight causing the display to show a negative tare value.

The scale must be stable within the stable window.

The unit will only zero if  is on and there has been no activity for two seconds. If a motion ceases within the motion window in that time, the scale will zero.

The scale will accept a zero setting over the full range of the scale (NTEP and other legal for trade scales may have limited zero range).



Zero settings above 4% of full scale will subtract from the overall capacity of the unit.

Example: If 100 lb on a 1,000 lb scale is zeroed, the overall capacity of the scale will reduce to 900 lb, plus the allowed over-range amount.

3.3 Tare

Tare is used to zero out a packing container or pallet, and display a **NET** weight. The **TARE** function is defined as a **Tare-In** or **Tare-Out** operation.

To tare the scale:



1. Hang/place the empty container from the scale.
2. Press  to enter a tare value. The MSI-8004HD stores the current weight as a tare value and subtracts the value of the container from the **GROSS** weight.  displays and the weight mode changes to **NET**.
3. Add the product to the packing container. The **NET** weight is displayed.



NOTE: To set a new tare, the existing tare must first be cleared. The MSI-8004HD will not set a new tare over an old tare.

3.3.1 View Tare

To view the **GROSS** weight without clearing the tare value:

1. Program  to the **NET/GROSS** function ([Section 4.3 on page 34](#)).
2. Press  to toggle between net and **GROSS** values. This will only work if a tare value has been established.



NOTE: The backup memory in the MSI-8004HD stores the Tare reading and can restore it even if power fails. Only positive **GROSS** weight readings can be tared. The **STABLE** annunciator must be on, indicating weight reading is stable. Setting or changing the tare has no effect on the **GROSS** zero setting. Taring will reduce the apparent over range of the scale. The RF Remote Control has **NET/GROSS** permanently available.

Example: Taring a 100 lb container on a 1,000 lb scale, the scale will overload at a NET weight of 900 lb (1,000-100) plus any additional allowed overload (usually 4% or 9d).

3.3.2 Clear Tare

To clear a saved tare value, press . The **GROSS** weight displays.



NOTE: Only positive gross weight readings can be tared.

The  must be off indicating weight reading is stable.

Setting or changing the tare has no effect on the gross zero setting.

Taring will reduce the apparent over-range of the scale.

The scale stores the tare value in non-volatile memory and is restored when power is cycled.

Example: Taring a 100 lb container on a 1000 lb scale, the scale will overload at a net weight of 900 lb (1000-100) plus any additional allowed overload (usually ~4% or 9d).

3.4 Print





is preprogrammed to Print.

- Press  to Print.







NOTE: The print option must be installed and the print function must be set up in order for the print button to work. See [Section 6.2 on page 51](#) for print setup information.

3.5 Function Keys

The  and  keys can be programmed in the setup menu ([Section 4.3 on page 34](#)) to one of the following functions. Some functions require additional programming in the setup menu to work correctly.

3.5.1 Test

Press   simultaneously to run a test of the MSI-8004HD.





When the  or  key is programmed to TEST (Section 4.3 on page 34), pressing the key prompts the scale to scroll through the following sequence and return to Weigh mode:

1. All LED segments light in orange at full brightness as a display test.
2. $50F\text{E}$ displays, followed by the software version number.
3. $5\text{t}R\text{nd}$ displays, followed by the legal-for-trade weighing standard.
4. $bR\text{t}\text{t}$ displays, followed by the battery volts.
5. $dR\text{t}\text{t}$ displays, followed by the date in "YY.MM.DD" format.
6. $\text{t } \text{t}\text{t}$ displays, followed by the time in 24 hour format.
7. $d. \text{t}\text{E}\text{t}$ displays, followed by the display counting from 00000 to 99999.
8. $\text{C} - \text{C}\text{AL}$ displays, followed by the C-CAL value.
9. MSI-8004HD enters Weigh mode.



 **NOTE:** Other internal tests are performed and if any test fails, an error code displays. See Section 8.0 on page 67 for information on the troubleshooting guide.

Single Step Test Mode

To stop the automatic scroll of the test procedure, begin the automatic scroll test and press **Fx-Test** again within two seconds to enable a single step test mode.

1. Press  to scroll through the available test functions.
2. Press  to start or display the individual tests.
3. Press  to exit individual tests.
4. Press  to exit from the test function.



3.5.2 Total

When the  or  key is programmed to $\text{t}\text{O}\text{t}\text{AL}$ (Section 4.3 on page 34), pressing the key prompts the scale to perform the total function that has been set in the setup menu. That can be, OFF , $\text{t}\text{t}\text{L}\text{O}\text{n}$, $\text{A. L}\text{O}\text{A}\text{d}$, $\text{A. L}\text{A}\text{S}\text{t}$, or $\text{A. H. I}\text{GH}$. For more information on these parameters and setup see Section 4.10 on page 38. If nothing has been set, nothing will happen when **Fx-Total** is pressed.

- Press **Fx-Total** to complete the total function



 **NOTE:** The Total mode must be programmed from the Setup menus before the USER key will function.

3.5.3 View Total

When the  or  key is programmed to $\text{v} - \text{t}\text{t}\text{L}$ (Section 4.3 on page 34), pressing the key prompts the scale to display total weight followed by the number of samples that have been saved.

1. Press **Fx-ViewTotal** to display the total weight.
2. With the Total weight displayed, press  to clear.

3.5.4 Net / Gross



When the  or  key is programmed to *NET/GROSS* (Section 4.3 on page 34), pressing the key prompts the scale to switch the display between **NET** and **GROSS** modes. This will only work if a tare value has been established.

- Press **Fx-NetGross** to toggle between NET and GROSS modes

NET weight is defined as **GROSS** weight minus a tare weight.



The operator can switch back to **GROSS** from **NET** without clearing the tare value. Only clearing or setting a new tare will change the tare value held before switching into **GROSS** mode.

3.5.5 Peak Hold

When the  or  key is programmed to *PEAK HOLD* (Section 4.3 on page 34), pressing the key clears and re-enables the scale to only update the display when a higher weight reading is established. The peak hold function uses a high-speed mode of the A/D converter allowing it to capture transient weights at a far higher rate than typical scales.



Peak hold is cleared and re-enabled with the **Fx-PeakHold** button.

3.5.6 Units

When the  or  key is programmed to *UNITS* (Section 4.3 on page 34), pressing the key changes the displayed units.

- Press **Fx-Units** to toggle display between available units

3.5.7 High Resolution Test Mode

When the  or  key is programmed to *HIGH RES* (Section 4.3 on page 34) and Standard is set to a legal-for-trade standard (HB-44 or R-76) (Section 6. on page 40), pressing the key prompts the scale to toggle between normal Weigh mode and High Resolution Test mode. High Resolution Test mode displays weight at x10 resolution. While in High Resolution Test mode, all of the annunciators flash to indicate that the weight display is not set to the approved legal-for-trade resolution.

- Press **Fx-HiRes** to toggle between normal and x10 resolution display

In some cases, the displayed weight in high resolution test mode will require seven digits to fully display. In these cases, only the six least significant digits will be displayed. The full weight can be displayed in normal resolution by pressing the function button.

Ex: 10000.02 kg displays as 0000.02 kg.





NOTE: High resolution test mode is for scale service and diagnostic use only.



Increasing the scale display resolution beyond the calibrated value does not increase scale accuracy.

High resolution test mode is not available in NTEP HB-44 legal-for-trade standard.

3.5.8 Channel Display

When the  or  key is programmed to *CHANNEL* (Section 4.3 on page 34), pressing the key prompts the scale to scroll through connected scan channels in order.

3.5.9 Add Load

When the  or  key is programmed to *ADD LOAD* (Section 4.3 on page 34), pressing the key prompts the scale to scroll through summing methods of connected load sensors. See Section 6.4.2 on page 57 for more information.







- All
- Pairs
- Both

4.0 Setup

This section provides an overview of the MSI-8004HD indicator setup instructions.

4.1 Setup Navigation

The front panel keys function as shown below, when navigating through the menus during setup.

- Press  to enter or select a parameter
- Press  to scroll through the parameters
- To enter a decimal point, press  while the digit is blinking
- Press  to save and go back one level or to weigh mode; *Σ* *OFF* displays briefly
- To change an entered value, press  to step back one digit
- Press  to change the digit
- Press  to exit without saving changes

4.2 Setup Menu

To enter the setup menu, press the  and  keys at the same time.



NOTE: Not all parameters are available when the regulatory setting is HB-44 or R76 (Section 6 on page 40).



Parameters	Choices	Description
<i>FUnc 1</i>		Function key 1 – Configurable to listed parameters (Section 4.3 on page 34); Default OFF
<i>FUnc 2</i>		Function key 2 – Configurable to listed parameters (Section 4.3 on page 34); Default OFF
	<i>OFF</i>	No function is assigned; The F-Key is disabled
	<i>TEST</i>	Test – Runs an LCD test (Section 3.5.1 on page 30)
	<i>TOTAL</i>	Total – Accumulates multiple weighments (Section 3.5.2 on page 30)
	<i>VIEW TL</i>	View total – Activates the total weight display followed by the number of samples (Section 3.5.3 on page 30)
	<i>NET/GROSS</i>	Net/Gross – Toggles between Net and Gross modes (Section 3.5.4 on page 31)
	<i>PEAK HOLD</i>	Peak Hold – Automatically updates the display when a higher peak weight reading is established (Section 3.5.5 on page 31)
	<i>2 UNITS</i>	2 Units – Switches the force units between lb and kg (Section 3.5.6 on page 31)
	<i>HI RES</i>	Hi Res – The unit is more sensitive to motion and movement resulting in a less stable display (Section 3.5.7 on page 31)
	<i>PRINT</i>	Print – Can be programmed to a F-key if desired; The MSI-8004HD has a dedicated print key so it is not necessary
	<i>TARE</i>	Tare – Can be programmed to a F-key if desired; The MSI-8004HD has a dedicated tare key so it is not necessary
	<i>CHAN</i>	Chan – Displays connected load cell channels in order
	<i>ADD. LD</i>	Add Loads – Switching display summing methods of local physical load sensors (all, pairs or both) (Section 6.1 on page 50)







Table 4-1. Setup Menu Parameter Descriptions

Parameters	Choices	Description
Auto Off	OFF 15 30 45 60	Auto Off – Prolongs the battery life of the scale by turning power off after the set time (in minutes) that the scale is not in use (Section 4.4 on page 34)
SLEEP	OFF 5 15 30	Sleep – Time (in minutes) before unit enters the sleep mode (Section 4.5 on page 35)
Display Intensity	AUTO Lo-1 Lo-2 Hi-1 Hi-2	Display Intensity – Used to set the display brightness (Section 4.6 on page 35)
Color	GREEN RED ORANGE Gr-rd	LED – Set the display color to green, red or orange (Section 4.7 on page 36) NOTE: When Gr-rd is selected, color changes based on passing setpoints 1 and 2; display color changes to orange when setpoint 2 trips; display color changes to red when setpoint 1 trips
Setpoints	--	Setpoints can be enabled/disabled only when using the indicator (Section 4.8 on page 36)
Setpoint 1-B	GREATER	Greater Than – Setpoint triggers when the tension exceeds the value
	LESS	Less Than – Setpoint triggers when the tension is less than the value
	OFF	Off - Setpoint parameter is disabled
Output		Relay Output – Dependant on the application being used
	LATCH	Latch – If power is lost, the relay retains it's settings
	COIL	Coil – Needs power to remain position
Total	OFF	Total Accumulation - Sets the choice for weight accumulation for a single scale See Section 4.10 on page 38; When set to off, it is disabled
	TOTAL ON	Total On - Is a manual choice for accumulation
	A. LOAD A. LAST H. HIGH	Auto Total - Choices for setting automatic accumulations
Filter	OFF LO Hi-1 Hi-2	Weight Filter – Allows the scale to adjust to situations where there may be movement See Section 4.11 on page 39

Table 4-1. Setup Menu Parameter Descriptions (Continued)







4.3 Function Keys

There are two programmable function keys on the MSI-8004HD,  and .

- , ,  and  are preprogrammed to the parameters noted on the key
- Function key setup is independent of the connected scale.
-  and  are standard on the MSI-8004HD and do not need to be programmed.
- If a function key does not work, the connected scale may not be set up to support the key

Example: If the Function key is set for TOTAL, then TOTAL mode setup in the Setup Menu must also be set up for the target scale.

To set a function key use the following steps:







1. Press  and  at the same time, *Func 1* displays.
2. Press  to scroll to the function key to be programmed.
3. Press . The currently saved parameter displays.
4. Press  to scroll through the settings.
5. Press  to select the desired setting.
6. Press  to save and exit.

4.4 Auto-Off

The Auto-Off feature powers off the unit when not in use. The time limit is reset when a button is pressed or the detected load is in motion exceeding 10 d. Using the battery option will save battery life.

When disabled, the unit only turns off by pressing , or if the battery dies.

To set the **Auto-Off** function:







1. Press and hold  and . *Func 1* displays.
2. Press  to scroll to *A-OFF*.
3. Press . The current auto off time displays.
4. Press  to scroll through the available times.
5. Press  when the desired time is displayed. *SLEEP* displays.
6. Press  to exit setup and store the settings.

4.5 Sleep

The **Sleep** parameter reduces power consumption by automatically dimming the display during periods of inactivity. To wake the unit, either a button must be pressed (front panel or RF remote), the weight must change by the amount set for Auto-Off (d) or there is a motion event.



NOTE: Sleep must be set to less time than the Auto-Off timer.





1. Press and hold  and . *Func 1* displays.
2. Press  to scroll to the *SLEEP* function.
3. Press . The current *SLEEP* time is displayed.
4. Press  to scroll through the available times.
5. Press  when the desired time is displayed.
6. Press  to exit setup and store the settings.

4.6 Display Brightness

The Display setup menu is used to set the display brightness. There are four fixed brightness settings and one automatic light-sensing brightness setting.



The Auto setting automatically detects the ambient light and adjusts the brightness of the display accordingly. Bright light causes the display to be at the brightest setting. The display brightness reduces as ambient light reduces.

There are four fixed brightness settings, **LO-1**, **LO-2**, **HI-1** and **HI-2**. Lower brightness settings increase battery life.

1. Press and hold  and . *Func 1* displays.
2. Press  to scroll to the *DISPL*.
3. Press . The current setting is displayed.
4. Press  to scroll through the available settings.



NOTE: The display brightness changes as each setting is displayed.

5. Press  when the desired setting is displayed. *SetPt 1* displays.
6. Press  to exit setup and store the settings.

4.7 Display Color

The MSI-8004HD display supports four color schemes. Three of the color schemes display a steady color. The fourth, *Gr-rd*, changes the color of the display when setpoints 1 and 2 are tripped (Section 4.8 on page 36). This is useful in warning of possible overload conditions..

Color	Description
<i>Gr-Grn</i>	Steady green
<i>red</i>	Steady red
<i>or-OrnGE</i>	Steady orange
<i>Gr-rd</i>	Variable Color — Display color changes based on setpoints 1 and 2; Gen 2 only Green — No setpoints have been tripped Orange — Setpoint 2 tripped Red — Setpoint 1 tripped  NOTE: Screen turns red if remote device is in any error state (underload, overload, uncal)

Table 4-2. Display Colors

4.8 Setpoints

MSI-8004HD display setpoints can be configured from remote devices or local math channel. If setpoint source is configured from remote devices, then setpoint event will be logical or with other remote device's setpoint event.

The MSI-8004HD supports eight LEDs for triggered setpoints. Common uses of setpoints are for warnings or process control.

The MSI-8004HD has an audible output option that is triggered by Setpoint 1. Contact Rice Lake Weighing Systems for other setpoint output options.

Setpoint	Description
Setpoint Mode	
<i>OFF</i>	Setpoint is not activated
<i>Gr-ERRt</i>	Indicates the setpoint will trigger when the weight exceeds a set value
<i>LESS</i>	Indicates the setpoint will trigger when the weight is less than a set value
Setpoint Weight Type	
<i>netGr</i>	Responds to net or gross weight
<i>Gr-gSS</i>	Responds to gross weight regardless of the display
<i>totAL</i>	Responds to the totaled weight
<i>t-cnt</i>	Responds to the total count (number of samples)
<i>LFcnt</i>	Responds to the number of times the weight has exceeded 25% of capacity

Table 4-1. Available Setpoint Settings

When the display color is set to *Gr-rd*, the MSI-8004HD is set to change the color of the display when setpoints 1 and 2 are tripped. This is useful in warning of possible overload conditions. This feature is not available with the blue LED display or when the display color is set to orange or red.















Setpoint 1	Setpoint 2	Display Color
Not tripped	Not tripped	Green
Not tripped	Tripped	Orange
Tripped	X	Red

Table 4-3. Display Colors- *Gr-rd* mode Only



NOTE: In *Gr-rd* mode, whenever setpoint 1 is tripped, the display will turn red, regardless of the state of setpoint 2.

To set the setpoint:

1. Press and hold  and . *Func 1* displays.
2. Press  to scroll to the desired setpoint (*SETE 1 - 8*).
3. Press . The current setpoint mode is displayed.
4. Press  to scroll to the setpoint mode desired.
5. Press . The current setpoint weight type is displayed.
6. Press  to scroll to the desired weight type.
7. Press . The desired weight type continues to display.
8. Press . *Sn 1-4* displays (*Sn 1-4* indicates setpoint source is from remote devices).
9. Press  to toggle between *Sn 1-4* and *Sn 5* (*Sn 5* indicates setpoint source is the local math channel).
10. With the desired setting displayed, press . The current weight type value is displayed.
11. Press  to scroll the numbers and  to enter each digit.
12. When the correct value is displayed, press . The next setup menu item is displays.



NOTE: To enter a decimal point, press  while digit is blinking. To correct a digit, press  to step back.

13. Press  to exit setup and store the settings.





4.9 Output

Relay output allows the selection of Latch or Coil relays.

- Latch relays retain position even if the power fails
- Coil relays reset when power fails





IMPORTANT: In the event of a power failure, the Latch relay uses continuous battery power and will deplete the battery more quickly than the coil relay.

1. Press and hold  and . *Func 1* displays.
2. Press  to scroll to *OutPut*.
3. Press . The current setting is displayed.
4. Press  to toggle between *Coil* and *Latch*.



NOTE: The display brightness changes as each setting is displayed.

5. Press  when the desired setting is displayed. *Net Wt* displays.
6. Press  to exit setup and store the settings.

4.10 Total Mode

For the accumulation of multiple weighments, the Total function uses the displayed load, so gross and net readings can be added into the same total.

There are four modes of totalizing, a manual and three auto modes.

All modes require that the weight on the scale return below 0.5% (relative to full scale) of **Gross Zero** or **Net Zero** before the next weighment can be added. Applied weight must be $\geq 1\%$ of full scale above **Gross Zero** or **Net Zero** before it can be totaled.

Manual Total

Manual Total (*Enter*) adds a current weight to a previously accumulated value manually. To add weight to the total it must be greater than 1% of capacity and not yet totaled. This assures that a weight on the scale is only added to the total once.

1. Program a **F-key** to **Total** (Section 4.3 on page 34).
2. With the weight to be added on the scale, press **F-Total**. The acknowledge LED blinks to indicate the weight was accepted and the **TOTAL** annunciator lights. Then the total weight is displayed for five seconds and the number of samples is displayed for two seconds.
3. Repeat steps 1 & 2 until all weight samples have been added.



NOTE: Total Mode will not function while the scale is in motion, ensure  is on. If the system fails to achieve stable readings, increase the filter setting or increase the size of the scale division (*d*) in the Init Cal procedure.

The F-Total functions as View Total only until the 1% threshold is exceeded to allow the addition to the total value.

Auto Total







This mode has three variations which are programmed in the Setup menu.

Program an **F-key** to **AUTO TOTAL**, it functions as **Auto Total On / Auto Total Off** (Section 4.3 on page 34).

Setpoint	Description
R_{Load}	Auto Load – ensures any settled load above the Rise Above threshold will be automatically totaled; The scale must fall below the Drop Below threshold before the next total is allowed
R_{Last}	Auto Last – takes the last settled weight to auto total with; The total occurs only once the scale goes below the threshold; This allows the load to be adjusted without a total occurring; Once the load is removed, the scale uses the last settled reading for total
R_{High}	Auto High – uses the highest settled reading; This is useful for loads that can't be removed all at once

Table 4-4. Auto Load Selections

Set Total Mode

1. Press  and  simultaneously. $F_{unc 1}$ will display.
2. Press  to scroll to total.
3. Press . The currently saved total mode is displayed.
4. Press  to scroll through the choices.
5. With choice displayed, press  to select. F_{iLLEr} will be displayed.
6. Press  to exit setup and store the settings.

Reset Total Load

To reset the total load to zero, press **Fx-Total** again and while the total load is being displayed, quickly press .



4.11 Filter





The Filter settings are used to stabilize the weight in an unstable condition. Increasing the filter will improve the stability, however settling times will be longer. The MSI-8000HD employs algorithms that speed up large weight changes while still controlling vibration even with high filter settings.

Parameter	Description
OFF	Disables filtering function
L_0	Low Filter
$H_1 - 1$	High Filter
$H_1 - 2$	Very High Filter







Table 4-5. Filter Parameters

Use the following steps to set up filtering.

1. Press  and  simultaneously. $F_{unc 1}$ displays.
2. Press  to scroll to F_{iLLEr} .

3. Press . The currently saved filter value displays.
4. Press  to scroll through the values.
5. With choice displayed, press  to select. *UNIT* displays.
6. Press  to save and exit to weighing mode.

4.12 Unit

1. Press  and  simultaneously. *FUNC 1* displays.
2. Press  to scroll to *UNIT*.
3. Press  *UNIT* displays with lb or kg in the lower right of the display area.
4. Press  to toggle between lb and kg.
5. With the desired choice displayed, press  to select.
6. Press  to save and exit to weighing mode.

5.0 Calibration

The MSI-8004HD is calibrated using standard weights. The weight used to calibrate, must be at least 15% of full capacity in order to achieve rated accuracy. For example, use at least a 750 kg test weight to calibrate a 5000 kg capacity scale. Although a single span point is usually adequate for rated accuracy, the MSI-8004HD supports Multi-Point calibration with up to four span points plus zero.

There are three kinds of calibration:

- **Standard Calibration** – Used for maintenance and routine calibration. (Section 5.2 on page 42)
- **Initial Calibration** – Used to set up both the capacity and resolution (d) of the scale. It differs from Standard Calibration only in the initial steps. The initial calibration is performed after a calibration reset which completely erases the calibration and setup memory. (Section 5.3 on page 43)
- **C-Cal** – Calculated Constant Calibration. Used when test weights are not available. To use C-Cal, a previously generated C-Cal number must be known. (Section 5.5 on page 45)

5.1 Calibration Switch



NOTE: To calibrate the MSI-8004HD indicator it must be put into the calibration mode. The MSI-8004HD may need to be resealed after calibration is complete to be in compliance with NTEP, Measurement Canada or OIML if applicable.

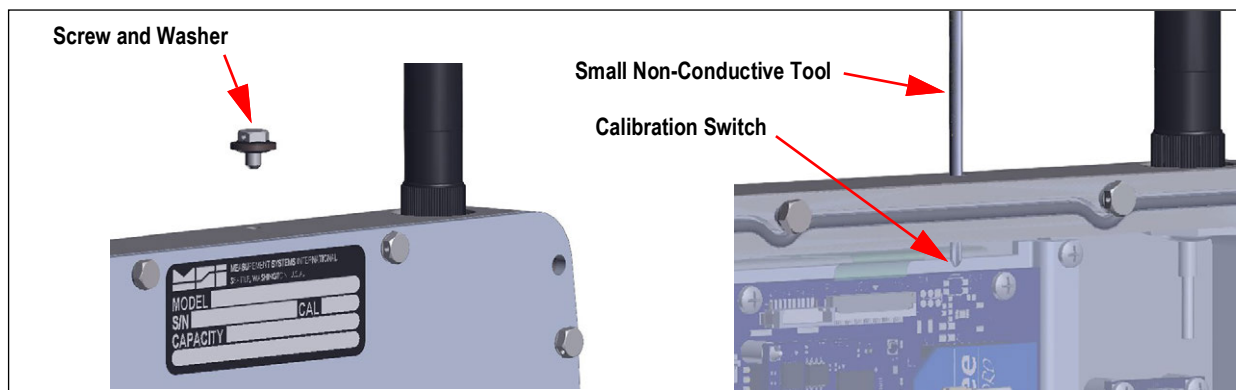

Figure 5-1. Calibration Switch

1. Remove screw and washer from the top of the unit.
2. Insert a small non-conductive tool into the hole far enough to press the switch. \overline{CAL} is displayed.



IMPORTANT: Caution should be used when pressing the configuration switch to avoid damage to the switch and other board components.

5.2 Standard Calibration

Use the following steps to calibrate the MSI-8004HD using the standard calibration procedure.

1. Select the sensor to be calibrated by pressing the **F-Key** that is programmed to \square HRN.
2. Press Cal switch to initiate Calibration. (Section 5.1 on page 41)

3. Press , UNL d displays.

4. Press  when the scale becomes stable, a blinking \square displays. If the scale is in range of zero, PASS displays, then LORd I displays.

5. Load the scale with a test weight.



NOTE: For a single span point calibration, a test weight of more than 15% of capacity or more is recommended

6. Press . The current capacity flashes on the display.



NOTE: If loading the scale with the capacity weight, skip to Step 9.

7. Press  to enter the value of the test weight. The far left digit blinks indicating a number should be entered.

8. Press  to scroll the numbers and  to enter each digit as in Section 4.1 on page 32.

9. Press  to save the weight entry. If the cal value is within limits, PASS displays briefly then LORd2.





NOTE: Display displays LORd3 and LORd4 after the second and third cal values have been entered. After the fourth cal value has been entered, CAL' d displays. Continue to .

10. If additional cal points are needed, press  and repeat steps Step 5 through Step 9 for each additional cal point.

11. When all cal points have been recorded, press . CAL' d displays to indicate that the calibration was successful.

12. Press  C-CAL briefly displays followed by the C-Cal number.

13. Press . SETOR displays momentarily, then SETUP displays.







14. Press  to exit calibration. SETOR displays momentarily, then the unit returns to weigh mode.

15. Replace the hex seal screw that was removed in Section 5.1 on page 41.

5.3 Initial Calibration







Use this procedure only if the capacity and count-by (d) needs to be modified. The initial steps of the initial calibration will totally erase user setup as well as any previous calibration.

Use the following steps to calibrate the MSI-8004HD using the initial calibration procedure.

1. Select the sensor to be calibrated by pressing the **F-Key** that is programmed to CHRN .
2. Turn the MSI-8004HD off.
3. Remove the hex seal screw using the steps in [Section 5.1 on page 41](#).
4. Press the and hold **Cal** switch; Press and release **Power** button and **Cal** switch. rESEt displays blinking.
5. Press  to reset the calibration constants. SURP displays blinking.
6. Press  to confirm. CAL displays.
7. Press  to start the configuration. Unit displays.
8. Press  to choose unit.
9. Press  to toggle between lb and kg.
10. Press  to confirm unit. CAP displays.
11. Press  to set scale capacity. Initial value of 10000 displays.



NOTE: 10000 is the initial default value. Capacity should be set no higher than the load cell rated capacity.

12. Press  to change the capacity. the first digit on the display blinks.
13. Press  to scroll the numbers and  to enter each digit as in [Section 4.1 on page 32](#).
14. Press  to store the capacity value. d displays.
15. Press  to choose scale divisions.
16. Press  to scroll through the recommended scale divisions.
17. Press  to select scale division. Unitd displays.
18. Calibrate the MSI-8004HD as in [Section 5.2 on page 42](#) beginning with [Step 3](#).

5.4 Guidelines for Capacity and Resolution

Capacity and resolution are set in the initial calibration of the MSI-8004HD.

5.4.1 Capacity

Setting capacity is determined primarily by the capability of the load cell.



NOTE: Never set the capacity of the scale higher than the rating of the load cell.

It is acceptable to set lower capacities to better match the crane the MSI-8004HD is used on. For example, if the hoist is rated for 9000 lb, use an MSI-8004HD with 10,000 lb capacity and reset the capacity to 9000 lb so that the scale will indicate overload at 9000 lb instead of 10000 lb. De-rating as much as 50% of the capacity is usually acceptable, but the scale may be less stable if the 'd' is decreased.

Due to kg to lb conversions, the capacity of all MSI-8004HD systems is rated approximately 20% higher than the rated capacity in pounds. This is to allow the kg capacity to be exactly 1/2 the number of the pound capacity.

5.4.2 Resolution

Due to Legal-for-Trade requirements and general scale design criteria, the weight must be stable for certain features to work:

- ZERO – Weight must be stable to be zeroed
- TARE – Weight must be stable to be tared
- TOTAL – Weight must be stable to be added to the total registers

If the MSI-8004HD does not become stable under standard operation, it is recommended that the resolution be reduced and/or filtering increased. Some improvement in stability can be achieved by increasing the filtering ([Section 4.11 on page 39](#)). Resolution is reduced by increasing the "d" value during initial calibration ([Section 5.3 on page 43](#)). Rice Lake Weighing Systems recommends that the resolution is kept in the 1:2000 to 1:3000 range. Never program the resolution greater than needed.

The third way to increase stability is to increase the **Motion Window**. The MSI-8004HD defaults to $\pm 1d$ as a motion window. It can be changed at Rice Lake Weighing Systems to a higher value if desired. Often $\pm 3d$ is chosen for bridge cranes as they tend to have a lot of bounce to them. This of course carries an accuracy penalty adding $\pm 3d$ to the total accuracy of the scale if the zero or tare operation happens to capture the weight in a valley or peak.



NOTE: Motion Window can only be changed by Rice Lake Weighing Systems.











5.5 C-Cal Calibration

When adequate test weights are not available, the MSI-8004HD can be calibrated using a programmed constant calibration number which is referred to as C-Cal. To perform C-Cal, a C-Cal number must be known from a previous calibration. Rice Lake supplies replacement load cells with the C-Cal value stamped on the serial number label. When a calibration is performed with test weights, a new C-Cal is generated. C-Cal can be used when the electronics are replaced to get an approximate calibration that may be suitable for non legal for trade applications.

IMPORTANT: The C-Cal number must be known prior to starting this procedure. For a MSI-8004HD with its original load cells, MSI prints this number on the calibration record and the serial number tag.

C-Calibration can be done if the electronics are replaced or a new load cell is installed. C-Cal reduces the absolute accuracy of the system and is intended for non-critical use only. If a system was originally multi-point calibrated, the C-CAL calibration will erase the additional span points, as C-Cal is only a two point calibration (zero and span at 10% of capacity).

Use the following steps to perform a C-Cal calibration.

1. Select the sensor to be calibrated by pressing the **F-Key** that is programmed to \overline{CHAN} .
2. Remove the hex seal screw from the MSI-8004HD and enter the calibration menu using the steps from [Section 5.1 on page 41](#).
3. Press  to scroll to the C-Cal menu selection. \overline{CAL} displays.
4. Press  to start the C-Cal procedure. \overline{UNLd} displays.
5. Remove all weight from hook.
6. Press  to set the zero calibration point. A flashing \square displays.
7. If the zero is in range, $PASS$ displays, followed by \overline{CAL}
8. Press  to confirm.
9. Press  to enter the C-Cal value. The first digit on the display blinks.
10. Press  to scroll the numbers and  to enter each digit as in [Section 4.1 on page 32](#).
11. Press  to save the C-Cal value. $PASS$ displays, followed by \overline{CAL} .
12. Press . \overline{SETUP} displays momentarily, then \overline{SETUP} displays.
13. Press  to exit calibration. \overline{SETUP} displays momentarily, then the unit returns to weigh mode.

5.6 Calibration Setup Menu

Remove the hex seal screw from the MSI-8004HD and enter the calibration menu using the steps from [Section 5.1 on page 41](#). It is important that all settings have been configured, including power savings, display color, brightness, and setpoints prior to setting the standard.



IMPORTANT: To press the Cal button, the seal must be broken. This removes the Legal for Trade setting and must be resealed by a qualified technician to continue as a Legal for Trade unit.

The Calibration Setup menu contains two additional items beyond Calibration:

- Legal Weighing Standard menu (SEtPnd)
- Gravity Compensation (GrAVo)
- Auto Zero Maintenance menu (AUt0M)

In addition, more menus will appear that are transferred from the main setup menu when Legal-for-Trade settings are used.

5.6.1 Legal Weighing Standard Menu

Selection	Description
Industrial (INDUS)	This is the most common setting for the MSI-8004HD; <ul style="list-style-type: none"> • Full range zero • Access to units switching, filters, and peak hold
Handbook 44 (HB-44)	Sets the scale to enable only approved features per the NTEP HB-44 rules and regulations; Access is denied to Peak Hold, and the zero range may be limited
R-76 (R-76)	Setting not relevant for non-OIML use; Sets the scale to enable only approved features per OIML R-76 <ul style="list-style-type: none"> • Only kg weight units are available • Zero range is limited to 4% (-1 to +3% relative to Calibrate zero) • Net/Gross function is temporary • Once Net weight is established, push of F key set for Net/Gross causes a max 5 second display of the Gross weight • Clear Tare displays Gross weight constantly • Only stable weights are printed • Negative weight display is limited to -20d • Other metrological aspects are changed to meet R-76 requirements
One Unit (UNIT)	The one unit Standard is exactly the same as Industrial, except units switching is inhibited; This is useful for Metric only countries; Another use of the One Unit standard is to allow the scale to be calibrated in units other than lb or kg, since conversions are eliminated; Contact Rice Lake Weighing Systems for more information on the Standards settings

Table 5-1. Legal Standard Menu Selections

Use the following steps to set up a Legal-for-Trade standard settings.

1. Remove the hex seal screw from the MSI-8004HD using the steps from [Section 5.1 on page 41](#) and $\bar{C}RL$ displays.

2. Press . SEtUP displays.

3. Press  to enter the Cal setup menu.

4. Press  to enter the standard menu. The current standard setting displays.

5. Press  to scroll to the desired standard. UNIT displays.

6. Press  to set the standard. AUt0CAL or the next item in the CAL setup menu displays.

7. Press  twice to exit setup and store all changes. St0RE displays.

5.6.2 Gravity Compensation

Gravity Compensation allows for calibrating in one geographic location for use in a different geographic location. Gravity can be set to OFF, ON, or Factor.

Parameter	Choices	Description	
OFF		Gravity compensation disabled	
ON	--	Calculates Gravity compensation using the origin and destination latitudes and elevations	
	LAtOr	0-90	Latitude of Origin - Original latitude (to nearest degree) for gravity compensation; 47 (default)
	ELeOr	-9999-9999	Elevation of Origin - Original elevation (in meters) for gravity compensation; 10 (default)
	LAtDt	0-90	Latitude of Destination - Destination latitude (to nearest degree) for gravity compensation; 47 (default)
	ELeDt	-9999-9999	Elevation of Destination - Destination elevation (in meters) for gravity compensation; 10 (default)
FACTOr	--	Calculates gravity compensation using origin and destination gravity factors	
	FRcOr	9.00000-9.99999	Gravity of Origin - Original gravity factor (in m/s ²) for gravity compensation; 9.8080 (default)
	FRcDt	9.00000-9.99999	Gravity of Destination - Destination gravity factor (in m/s ²) for gravity compensation; 9.8080 (default)

Table 5-2. Gravity Compensation Parameters



NOTE: To find the local gravity, enter the latitude and elevation into the International Gravity Formula. Listed are links to websites that can be used to determine local latitude and elevation. Please note these website addresses are provided for reference only and may change.













Map Coordinates uses Google maps to find latitude and elevation: www.mapcoordinates.net/





Once local latitude and altitude have been determined, use the following link to calculate local gravity <http://www.sensorone.com/local-gravity-calculator/>















IMPORTANT: The gravity correction function has not been evaluated by an approvals agency, therefore it is up to the authorized scale dealer to ensure the device is accurate at the intended point of use.

Compensation by Latitudes and Elevations

1. Press  and  simultaneously. LAL displays.
2. Press  to scroll to SEtUP.
3. Press . SEtUPd displays.
4. Press  to scroll to CRAC.
5. Press . The current setting displays.
6. Press  to scroll to ON.
7. Press . LAtOr displays.
8. Press  to enter latitude of origin.
9. Press . ELeOr displays.
10. Press  to enter elevation of origin.
11. Press . LAtDt displays.
12. Press  to enter latitude of destination.

13. Press . *ELEdE* displays.
14. Press  to enter elevation of destination.
15. Press  to accept elevation of destination.
16. Press  twice to save settings. *StorE* displays briefly and exits setup.



Compensation by Gravity Factor





1. Press  and  simultaneously. *CRd* displays.
2. Press  to scroll to *SEtUP*.
3. Press . *StAnd* displays.
4. Press  to scroll to *GrAcO*.
5. Press . The current setting displays.
6. Press  to scroll to *FACtOr*.
7. Press . *FACtOr* displays.
8. Press  to enter original gravity factor.
9. Press . *FACtE* displays.
10. Press  to enter destination gravity factor.
11. Press .
12. Press  twice to save settings. *StorE* displays briefly and exits setup.

5.6.3 Auto Zero Maintenance

The MSI-8004HD employs an auto-zeroing maintenance mechanism to adjust the zero reading to the center-of-zero (COZ). COZ is defined as the weight reading is within 1/4 'd' of zero. AZM continuously adjusts zero to maintain COZ. It is recommended that AZM is on to maintain the highest accuracy. However, there are circumstances when it should be turned off. This can happen when minor variations of weight occur while picking up scale attachments and the variations fall within the AZM capture window. The AZM capture window (usually 1 'd') and capture time (usually eight seconds) can be adjusted by MSI to meet custom requirements. The settings of AZM are dictated in Legal-for-Trade standards and cannot be adjusted.

Use the following steps to set up the auto zero maintenance.

1. Remove the hex seal screw from the MSI-8004HD using the steps from [Section 5.1 on page 41](#) and *CRd* displays.
2. Press . *SEtUP* displays.
3. Press  to enter the Cal setup menu. *StAnd* displays.

4. Press  to scroll to the Auto0 menu. *Auto0* displays.
5. Press  to enter the Auto Zero menu. The current setting (blinking) displays.
6. Press  to scroll between the on or off key.
7. Press  to set the auto zero. *SetAnd* displays.
8. Press  twice to exit setup and store all changes. *STORE* displays.

6.0 Communications

The MSI-8004HD uses 802.15.4 transceivers to communicate which operates in the 2.4 GHz systems if:

- Antennas are isolated at least 10' (3 m) from the equipment
- MSI-8004HD based RF systems are peer to peer; In multiple scale connections, it acts as the network coordinator

The MSI-8004HD uses three numbers to establish a piconet. [Table 6-1](#) lists out the three elements used in setting up a piconet.



IMPORTANT: Unit comes preconfigured from the factory. Any changes will affect factory configuration. Consult Rice Lake Weighing Systems before changing any of these settings.

Name	Description	Recommended Number Range
ScaleCore ID	Used to identify each device in a piconet, its range is 0–254 and cannot be duplicated within the same RF channel	20–30
RF Channel	Establishes the base network that all interconnected devices must match	12–23
Network ID	A 64-bit number that all interconnected devices must match, do not use a small number to avoid other 802.15.4 transceivers that default to a network ID of 0	Maximum of five digits with a range of 0–65535

NOTE: For all devices that interconnect, the RF channel and network ID must match. The ScaleCore ID must be unique. The Dyna-Link or crane scale that is the weight source should be set to a ScaleCore ID of 0. If other source devices are added, they can be added in sequence.

Table 6-1. Piconet Setup Ranges

6.1 Communications Menu

To enter the **Communications** menu, press  and  at the same time. **Busy** flashes momentarily before entering the communications menu.printer setup.

Parameters	Settings	Description
Print	--	Print – Prints a ticket if connected to a printer (Table 6-3)
RF	--	Radio Frequency – See Table 6-7 on page 54
Add on	Load	Load Totaling – The total number of Remote Sensor Devices (RD's) – Range 1-4 (Default is 1)
	Method	Methods of summing load pins ALL – Sum of all pins Pairs – Sum in pairs (requires four remotes) both – Sum in pairs plus grand total USEDEF – Programmed using a computer program such as ScaleCore Connect OFF – Summing is disabled
SCALES	Scale ID	–
	Scale ID	ScaleCore ID – Number must match
	Sensor ID	Sensor ID
DATE	YEAR	Date/Time – Set date and time for printing output (Section 6.2.3 on page 53)
	Month	
	DAY	
	hour	
	minute	

Table 6-2. Communications Menu Parameters

6.2 Printer Setup

The RS-232 communications port is capable of outputting load data. Several RF linked device weight modes are available in user formatted form. The control mode directs the MSI-8004HD to print ([Section 6.2.1 on page 51](#)).

The communications port settings are independent of print settings in connected scales. They are only in the MSI-8004HD.

Settings	Description
<i>L iStnr</i>	Print Setup – Select the channel the port will be used with; Options: <i>0</i> , <i>1</i> , <i>2</i>
<i>OutPut</i>	Port Selection – Select the port to use for communication with the printer; Options <i>Port 0</i> , <i>rF</i> , <i>Port 2</i>
<i>StrenG</i>	String Setup – Print string format number entry screen (Table 6-6)
<i>Ctrl</i>	Print Control Options: <i>uSEr</i> , <i>LoAd</i> , <i>Cont</i> , <i>OFF</i> (Table 6-4)
<i>rAtE</i>	Output Rate – Print string output rate number entry screen (0–65535 seconds)

Table 6-3. Print Setup Parameters

6.2.1 Control Modes

The user can select four control modes. They are described in [Table 6-4](#).

Mode	Description
<i>uSEr</i>	Printing is controlled by pressing F-3 Print
<i>LoAd</i>	One print occurs when a stable load is read, the scale must return to near zero before another print occurs NOTE: Other configurations of load are available using the ScaleCore Connect. It can be downloaded from the Rice Lake Weighing Systems Website.
<i>Cont inuous</i>	The unit will continuously output the data at a rate specified in the rate parameter (up to 65,535 seconds); Setting the interval to 0 will set an interval as fast as the system can go
<i>OFF</i>	Printing is disabled; Power consumption is lower with the print off

Table 6-4. Control Modes

6.2.2 Standard Print Strings

Commands that can be used to format gross, net and print strings are shown below.

Command	Description
<T>	Load data
<U>	Units
<M>	Load mode (lb/kg)
<CRLF>	Carriage return line feed
<SP>	Space
<STX>	Start of text character (ASCII 2)
<P>	Space for positive, - for negative
<W7.>	7-digit weight, floating decimal, leading spaces
<S>	Status, upper case: <SP> =OK, M=Motion, O=Overload, Z=Zero, I=Invalid

Table 6-5. Print String Commands

Print String Number	Parameter	Description
1	Current load	Fixed output length: 16; Leading zeros suppressed except for the least significant digit (LSD) <TTTTTT><SP><UU><SP><MMMMM><CRLF>
2	Net load	Fixed output length:16; Leading zeros suppressed except for the LSD <TTTTTT><SP><UU><SP>NET<SP><SP><CRLF>
3	Gross load	Fixed output length: 16; Leading zeros suppressed except for the LSD <TTTTTT><SP><UU><SP>GROSS<CRLF>
4	Tare Weight	Fixed output length: 16; Leading zeros suppressed except for the LSD <TTTTTT><SP><UU><SP>TARE<CRLF>
5	Total Weight	Fixed output length: 16; Leading zeros suppressed except for the LSD <TTTTTT><SP><UU><SP>TTL<CRLF>
6	Number of Samples Totaled	Fixed output length: 16; Leading zeros suppressed except for the LSD <SP><SP><SP><SP><SP><SP><SSSSSS><SP><T-CNT>SP<CRLF>
7	Rice Lake / Condec:	Stream Data Format; <STX><P><W7.><U><M><S><CR><LF>
8/9	Carriage Return/Line Feed	Used to add a space between print records; <CRLF>

Table 6-6. Standard Print Strings













NOTE: If unit is in legal for trade mode (r76-HB44) the only print string available is number 1.

Combinations of the standard print strings can be entered in the string number entry screen.

Example: To get a Net, Gross, Tare printout with a space between records, enter 2349.













6.2.3 Printer Output Setup

Use the following steps to set up the printer output.

1. Press  and  at the same time. *Prnt* displays.
 2. Press . *LIST* displays.
 3. Press  to scroll to *STRT*.
 4. Press . The current print string number is blinking.
 5. Press  to scroll through the numbers then press  to save number and move to the next digit.
- Example: If Net, Gross and Tare are to be used for the print format, the entry required is 2349. The 2 is net, 3 is Gross, 4 is Tare and 9 inserts a space before the next print output.*
6. Once value is set, press  to save the print mode. *ENTR* displays.
 7. Press . The current control mode displays.
 8. Press  to scroll through the options.
 9. When the desired control mode is displayed, press . *RTT* displays.



NOTE: If control mode has been set to continuous, press  then continue to [Step 13 on page 53](#).

10. Press . The current print rate displays.
11. Press  to scroll through the numbers and press  to save number and move to the next digit.
12. When value is correct, press . *LIST* displays.
13. Press . The current listener value displays.
14. Press  to scroll through the numbers and press  to save number and move to the next digit.
15. Once the desired value is displayed, press  to save. *OUTPUT* displays.
16. Press . The current output displays.
17. Press  to scroll through the options.
18. Once the desired output is displayed, press  to save. *STRT* displays.
19. Press  three times to exit, *STRT* displays briefly then the unit returns to weigh mode.

6.2.4 Custom Print Formatters

The ScaleCore Connect application is used to create custom output formatters. Download the ScaleCore Connect software from the Rice Lake website. For more information see the ScaleCore Connect software manual (PN 185725).

Custom formatters are also configured in the ScaleCore Webserver. For more information, see the ScaleCore Webserver technical manual (PN 208738).

The serial output is configured as 9600 baud, Xon/Xoff handshaking, no hardware handshaking, 1 stop bit, no parity.

Other baud rates are possible by special order only.

6.3 RF Network Setup

The MSI-8004HD allows the use of dual RF modems. In addition to the XBee modem other options include:

- FHSS
- Wi-Fi
- Wired Ethernet

Contact Rice Lake Weighing Systems or a local dealer for more information about these options.



NOTE: All settings except for *On/Off* and *hold* are only applicable to the XBee radio

Mode	Description
<i>On/Off</i>	Enable RF – On/Off, affects continuous mode only
<i>Scale ID</i>	ScaleCore ID – Range 1–254, (20–30)
<i>Channel</i>	RF Channel – Range 12–23 NOTE: The RF communication channel is not the same as the scan channel and is not preprogrammed to the F2 key.
<i>Network ID</i>	Network ID – Range 0–65535
<i>Strength</i>	Transmission Strength – Range 0–4 (Table 6-8)
<i>TYPE</i>	Select radio module that is being used; Select <i>ZBEE</i> when the XBee radio module is installed; For all other radio modules, use <i>OTHER</i>
<i>hold</i>	When set to ON, the radio continues to use power when the MSI-8004HD is turned off. In battery powered applications, this will use some battery power even when the MSI-8004HD is turned off. This is required to be set to ON if using the Rugged Remote with the MSI-8004HD. Default is set to OFF.

Table 6-7. RF Setup Parameters - XBee Modem Only



NOTE: It is possible to have multiple separate MSI ScaleCore RF networks in the same location. Each device on the same network must be on the same channel.

For best performance, different ScaleCore networks should be on different RF channels.

















NOTE: Transmission strength should be set to the lowest setting possible to achieve the transmission required. Both the MSI8004HD RF Indicator and the load sensor should be set at the same transmission strength setting.

Setting	RF Power Level	Transmit Current	Note
0	10 dBm	137 mA	Lowest Transmission Power
1	12 dBm	155 mA	Default on 7300s and 8000s
2	14 dBm	170 mA	–
3	16 dBm	188 mA	–
4	18 dBm	215 mA	–

Table 6-8. Transmission Strength Settings - XBee Radio Only













Use the following steps to set up the RF menu parameters.

1. Press and simultaneously. *PRINT* displays.
2. Use the to scroll to *RF*.
3. Press . *On/Off* displays.

4. Press . The currently saved parameter is displayed.
5. Press  to toggle between \square_n and $\square FF$.
6. With **On** displayed, press  to select. Use $\square FF$ when the unit is hardwired to a Dyna-Link. Sc id displays.
7. Press . The current ScaleCore ID displays.
8. Press  to scroll through numbers and  to save number and move to next digit.
9. When value is correct, press  to store. $ChnL$ displays.
10. Press . The current channel setting displays.
11. Press  to scroll through numbers and  to save number and move to next digit.
12. When value is correct, press  to store. nEt id displays.
13. Press . The current Network ID displays.
14. Press  to scroll through numbers and  to save number and move to next digit.



NOTE: Rice Lake Weighing Systems recommends at least a four digit for the Network ID, to ensure there are no conflicts with any other 802.15.4 networks.

15. When value is correct, press  to store. $StrEn$ displays.
16. Press . The current strength setting displays.
17. Press  to scroll through 0–4.
18. When the number is correct, press . $TYPE$ is displayed.
19. Press . The current type displays.
20. Press  to scroll through values.
21. With selected value displayed, press . $Hold$ displays.
22. Press . The current setting displays.
23. Press  to toggle between on and off.
24. When the selection is correct, press  to store. \square_n . $\square FF$ displays.
25. Press  to save and exit the RF menu.
26. Press  to exit to the communication menu.

6.4 Setup Multiple Sensor Network

The MSI-8004HD can monitor up to four load sensors. The sensors can be read individually, in pairs or summed.

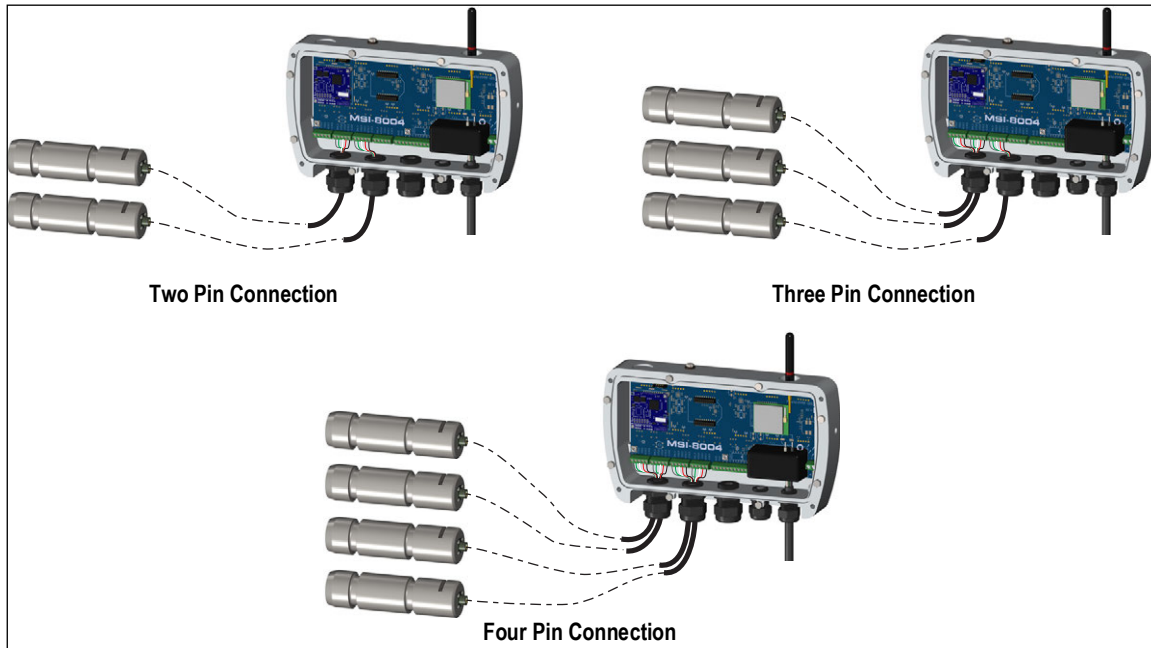

Figure 6-1. Multiple Sensor Network

Each load pin has a unique ScaleCore ID (SCID). The IDs must be consecutive, starting with 0.

6.4.1 Set the Total Number of Load Sensors

1. Press **F1 UNITS** and **PRINT F3** at the same time. *Prnt* displayed.
2. Press **F2 CHAN** to scroll to *Add*.
3. Press **F1 UNITS**. *Ln. Ld* is displayed.
4. Set the number of load cells attached (2-4) by pressing **F2 CHAN** to scroll through the numbers and press **F1 UNITS** to save and move to the next number.
5. With correct number of load pins displayed press **F1 UNITS**.
This number does not include the MSI-8004HD or any modems. *Add. Ld* displays.
6. Press **F1 UNITS**. The current summing mode displays.
7. Press **F2 CHAN** to scroll to the desired summing mode.
8. Press **F1 UNITS**. *Ln. Ld* displays.
9. Press **ZERO** twice to exit to the weigh mode.

6.4.2 Load Totaling Settings

The four different types of load totaling modes are explained below.

All

All channels are added together. Press **Fx-Add.Ld** to view the sum of all sensors connected. Press **Fx-Add.Ld** again. *Add. Ld* (Add Loads) displays to confirm that the summed channels are being displayed.



NOTE: If only the sum is to be observed, disable the Chan function key using the function key setup menu (Section 4.3 on page 34).

Pairs

Pairs is used with four sensor systems, scrolling through the channels with *Fx-Add. Ld*, they will be presented as separate weights first and then as pairs. This display is preceded by the LCD message *PA r 1* and *PA r 2*.

Both

This mode displays both the pair totals and the overall total. Each press of *Fx-Add. Ld* scrolls through the summed combinations. First *PA r 1*, then *PA r 2* then the sum of all connected sensors is displayed.



Off

Sensor summing is disabled. A function key set to *Add. Ld* (Add Loads) is unnecessary. Use the following steps to set the Load Totaling parameters.



1. Program an F-key to the *Add. Ld* function (Section 4.3 on page 34). The current channel is displayed.
2. Press **Fx-Add.Ld**. *Add. Ld* is displayed briefly, then the summed total.

Continue pressing **Fx-ttl.rd** to view all enabled sum types.

6.4.3 Scan Weight Inputs

1. Program **F2** to *Chan* if necessary (**F2** is programmed to *Chan* at factory).
2. Program **F1** to *Add. Ld* for summed sensor readings (Section 6.4.2).
3. With the current channel displayed, press  to change display to the next channel. The scan channel number is displayed briefly, then the scan channel weight is displayed.
4. Press . In a two sensor system the *Chan* returns to the first channel (0).

6.5 Zero and Tare in Multiple Load Pin Systems

The channel that is displayed is considered the **Focus Channel**. Pressing  or  affects only the displayed channel. When displaying summed channels, ZERO or TARE commands will be sent to all devices that contribute to the displayed weight.

*Example: If in the **Both** mode, and displaying pair 1 (sum of SC0 and SC1), pressing **ZERO** will zero only SC0 and SC1. If displaying the grand total using the **ALL** mode, pressing **ZERO** will zero all connected sensors.*

6.5.1 Using the Tare Function

If one device is tared in the individual display mode, the summed weight will be the sum of a Net and a Gross weight.

If **TARE** is pressed when displaying any of the summed modes, all devices that add to the current display are tared and placed in **Net** mode.

6.6 Real Time Clock

RTC capability enables the time and date to be included when printing load data. Time and date only display on the LCD screen during the power-on sequence or during the TEST sequence. Time displays in a 24-hour clock format and date displays as “YY-MM-DD”. Print time and date formatting is determined by the programmed print string.



NOTE: Time and date support is not available on older versions of the MSI-8004HD. If time and date support is not available, time and date will either not display during the display TEST or the time and date will show up as all zeros. If you would like time and date support and your MSI-8004HD does not support it, please contact your dealer.

Allows the setup of the time and date.

Mode	Description
YEAR	Two-digit year
Month	Month (1-12)
DAY	Day of the month (1-31)
hour	Hour on a 24-hour clock 0 — 12:00 am, midnight 1-11 — AM hours 12 — 12:00 pm, Noon 13-23 — PM hours
MINUTE	Minute (0-59)

Table 6-9. RF Setup Parameters

Press ZERO twice to save the time and date. Seconds reset to zero upon saving.

6.7 Communications Port Hardware

Serial Communications defaults are set to:

- **Data Configuration:** The data output is fixed at 8-1-N.
- **Baud Rate:** Baud rate is not programmable. Serial port J6 is set at 38.4 k baud. RF2 is set to 9600 k baud.
- **Handshaking:** No hardware handshaking is supported. Xon/Xoff software handshaking is always on.

Remove the back cover of the MSI-8004HD to access the serial connectors and connect the cable (Section 2.4 on page 12).

The MSI-8004HD has two serial comm ports (Figure 6-2).

- Comm port 1, P5 is directly wired to the external Turck® serial connector. Comm port 1 is used for software updates, connecting to a remote display and for connecting to an RS-232 device.
- Comm Port 2 is either configured as a second wired serial port (J6 or P6) or the RF 2 radio module (Section 2.6 on page 16).



NOTE: Serial Port P6 parallel to serial port J6. If MSI-8004HD is configured for 2 wired Turck connectors, the second Turck connector is wired to P6.

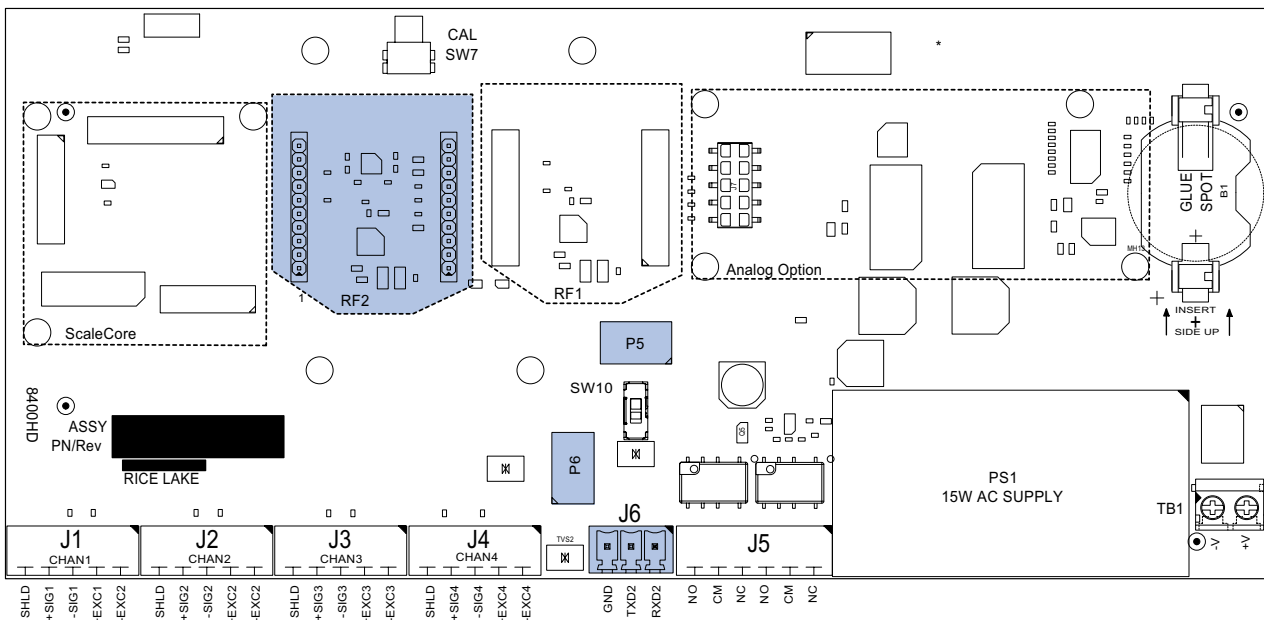

Figure 6-2. Connectors

Comm Port 2 only supports one connection at a time. Serial port J6 must be disabled for RF2 to function. Enable or disable serial port J6 by toggling SW10, located on the main circuit board directly above terminal block TB6 (Figure 6-3).

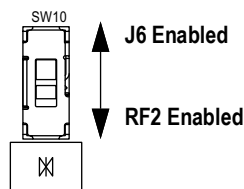

Figure 6-3. Switch SW10

If using J6 as comm port 2, route a cable with RS-232 signals through a cord grip. Wire the other end to a nine pin female connector as in [Figure 6-4 on page 60](#).

IMPORTANT: Wire shield drain to the metal shell of the connector. Disconnect shield drain wire if ground loops cause unstable readings. If necessary use an isolated RS-232 interface.

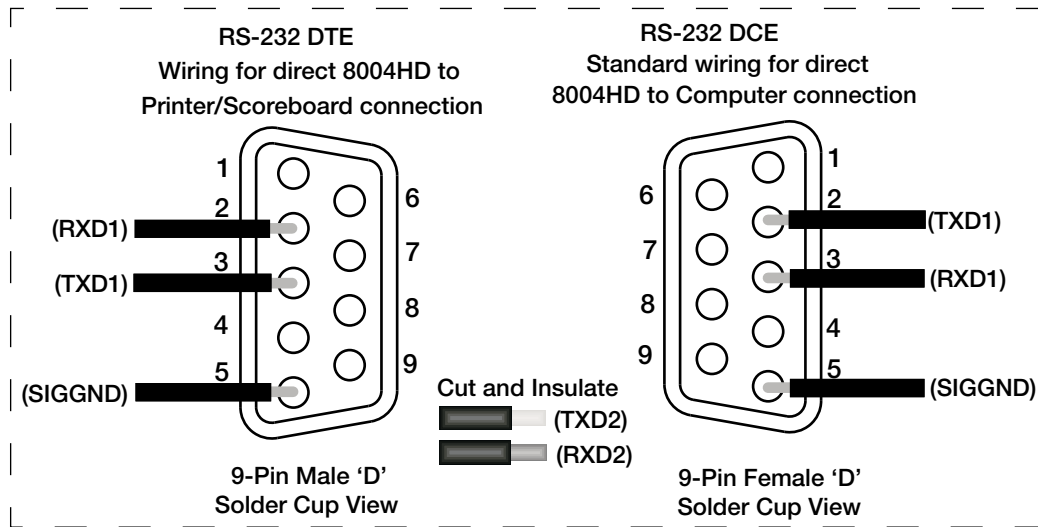

Figure 6-4. Communication Wiring

6.8 Relays

The MSI-8004HD is equipped with two 5 V coil, 250 VAC, 5.0 A, relays for process control or safety systems. Wire the relays to the terminal block, J5 (Figure 6-5). The relay option connecting cables are shown in Table 6-11.

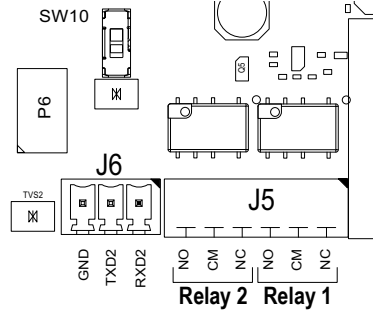

Figure 6-5. Switch J5

Two independent relays are factory installed and are wired out to 4 pins on a M12 connector. The connecting cables are shown in Table 6-10.

Part No.	Description
144440	PVC 4 m, rated to 250 VRMS, 4 A
-	PVC 10 m, rated to 250 VRMS, 4 A
Alternately use a field wire able connector	
156256	Conn, Female 4 pin field wire able, IP67
-	Right angle for 4-6 mm
-	Straight for cable 6-8 mm OD
-	Right angle 6-8 mm OD

Table 6-10. Relay Connector Cable Part Numbers

6.8.1 Relay Options

The two included relays are normally open (1 Form A). Specifications for included and optional are listed below.

Relay Type	Description
AC/DC coil relay	<ul style="list-style-type: none"> AC/DC Coil Relay: 144520 PA1a-5 V. 4 A Fuse: 144307 AC Rating: 250 VAC at 5 A.(limited by connector/cordset rating to 5 A continuous) DC Rating: 5 A at 30 VDC, 0.5 A at 100 VDC Best choice for 90% of applications

Table 6-11. Standard Relay

6.8.2 Extended Relay Kit – Optional

Relay expansion kit is available with either 4 or 8 relays

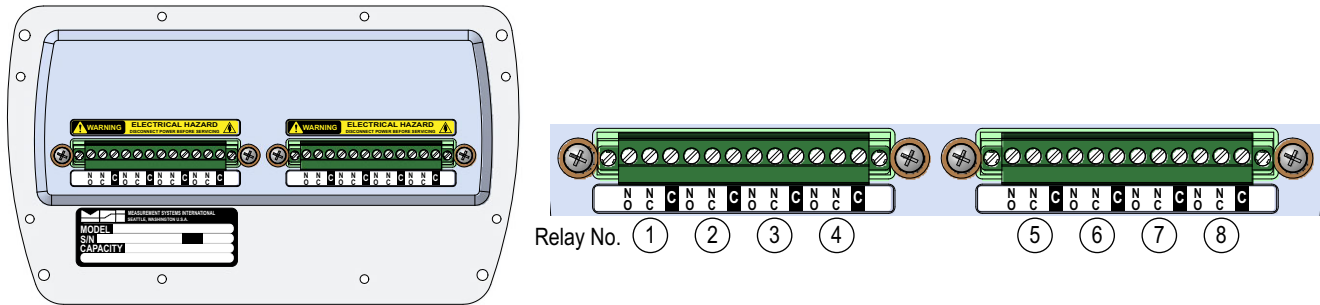

Figure 6-6. Extended Relay Kit:

Part No.	Description
172502	8-CH 0.9 A 200 VPK SSR FORM C
172501	8-CH 3 A 60 VPK SSR FORM C
172500	4-CH 3 A 60 VPK SSR FORM C
172498	8-CH 0.9 A 200 VPK SSR
172497	8-CH 3 A 60 VPK SSR
172495	8-CH 12 A 5 V RELAYS MOMENTARY
172494	4-CH 0.9 A 200 VPK AC/DC SSR
172493	4-CH 3 A 60 VPK AC/DC SSR
172492	4-CH 5 V MOMENTARY
172490	4-CH 5 V LATCHING RELAYS
171676	8-CH 12 A RELAYS LATCHING

Table 6-12. Expanded Relay Option Kits

Relay Type	Description
AC/DC SSR (solid state relay) - 60V	<ul style="list-style-type: none"> Better for battery powered units and mates well with 24VDC industrial power supplies AC/DC SSR 60 VPK, 2.7 A: 13178 AQZ202D. 2 A Fuse: 144319
AC/DC SSR - 120V	<ul style="list-style-type: none"> For 115VAC operation when SSRs are preferred AC/DC SSR 200 VPK. 0.9 A: 13180 AQZ207D. 0.75 A Fuse: 155221
Other available relays	<ul style="list-style-type: none"> AC/DC SSR 100 VPK, 2 A: 13179 AQZ205D. 1.5 A Fuse: 155220 AC/DC SSR 400 VPK, 0.45 A: 13181 AQZ204D. 0.375 A Fuse: 155222 (Use limited to 250VRMS due to connector and Cordset limitations) DC Only SSRs DC SSR 60 VPK, 4 A: 13182 AQZ102D. 3 A Fuse: 155223 DC SSR 200 VPK, 1.3 A: 14566 AQZ107D. 1 A Fuse: 160448 <p>NOTE: Normally open relays (1 Form A) can be made to function as normally closed (1 Form B) by programming the setpoint as a less than type. If the 8000HD is turned off or loses power, they will open.</p>
One 1 Form B closed SSR	AC/DC SSR 400 VPK, 0.5 A: 14628 AQZ404. 0.5 A Fuse 144583 (Use limited to 250 VRMS due to connector and Cordset limitations); Requires a minor modification on the Relay board and can only be ordered by contacting Rice Lake Weighing Systems

Table 6-13. Relay Options

6.9 Antenna Options



NOTE: To meet FCC licensing rules, use only antennas supplied or recommended by Rice Lake Weighing Systems.

Antenna placement is critical to problem-free use of the system.

- Ensure a relatively clear transmission path exists between the devices to be connected; Radio signals travel primarily by line of sight (LOS), obstructions between stations may degrade the system performance
- When using the long range antenna, mount the antenna on an elevated structure to ensure that you have a clear LOS transmission path; This will ensure the antenna will clear surrounding obstructions; Do not provide a ground plane for the antenna
- Fixed station locations often benefit from directional antennas when the location of the other components of the RF network are fixed and/or in the same direction; Never use a directional antenna on a mobile system
- If using the standard antenna, ensure the antenna is not blocked by any metal; Transmission is good through most kinds of glass so mounting a meter next to a window will work fine; If there is no clear line of sight place to mount the receiving device, consider switching to the long range antenna so the antenna can be set up remotely
- The standard and long range antennas are vertical plane devices; They should be vertical, pointing up or down, when high off the ground (like the underside of a large bridge crane); Do not mount them sideways; The long range 9 dBi antenna is particularly sensitive to off axis mounting; Use a level to ensure the antenna is exactly 90° perpendicular to the earth
- Do not mount an omni-directional antenna next to metallic or concrete surfaces; This can result in reflections and undesired RF characteristics; Use a corner reflector instead
- After installation, seal the antenna connection with an adhesive heat shrink boot; Failure to seal the antenna may result in liquid destroying the antenna and device it's connected to



NOTE: Rice Lake Weighing Systems does not recommend extending the coaxial cable beyond three meters.

At 2.4 GHz more loss will result from coax losses than are gained by raising the antenna. If the antenna must be extended, use a very low loss 50 ohm coax such as RG-214, RF-195, or other low loss varieties.

For very short extensions (<1m), cables made with RG-316 are suitable.

Standard Antenna

The standard antenna is an articulated 1/2 wave 2 dBi gain design with a standard TNC connector that mounts directly on the enclosure.

This antenna and coax connector, though resistant to water, is not water-proof. Seal the TNC base with an adhesive heat shrink boot if this antenna might be exposed to rain or other weather conditions where it could get wet.

This antenna must be vertically oriented and is suitable for most short to medium range applications.



Long Range OMNI 9 dBi Antenna

This omni-directional high gain antenna is remotely mounted with a low loss coaxial cable and increases the range up to four times.

The antenna must be vertically mounted. The vertical Beamwidth (-3dB point) is 14 degrees.

This antenna is supplied with a 10 foot (3m) coax cable pre-attached. The 10-foot cable allows placement of the antenna above the unit for ease of clearing possible obstacles to data transmission. It is also available with an N connector for applications requiring longer coax cable lengths.

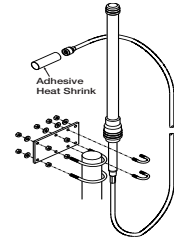

Vehicle Mount Whip Antenna

The vehicle mount whip antenna mounts directly to the roof of mobile vehicles and is weatherproof.

This 5 dBi gain whip mounts in a 3/4" hole on the roof of the vehicle.

The mount includes 17' of low loss coax terminated in a TNC connector.



YAGI Antenna

For maximum range, a 14 dBi gain Yagi Antenna is available by special order. Please contact Rice Lake Weighing Systems for details.



Corner Reflector Antenna

Corner reflector antennas are often the best choice for a wall mounted antenna. Rice Lake Weighing Systems offers a 14 dBi and a 9 dBi corner reflector.



14 dBi Corner Reflector



9 dBi Corner Reflector

Patch Antenna

The patch antenna is for applications where the standard antenna is vulnerable to physical damage or outdoor applications. The patch antenna is mildly directional which requires more care in antenna placement for long range applications. Patch antennas are available by special order only. Please contact Rice Lake Weighing Systems for details.

7.0 Optional Rugged Remote

The MSI-8004HD with an installed RF modem can be controlled with an optional Rugged Remote (PN 173014). The Rugged Remote is a transmit only device that can be used to perform basic scale functions. The range may vary up to 100 ft or more depending on room conditions and line of sight.

The RF modem in the MSI-8004HD must be configured to accept communication from the Rugged Remote, contact Rice Lake Weighing Systems for pairing requirements.



NOTE: A Rugged Remote is paired to an individual device and cannot be reprogrammed in the field.



Figure 7-1. Rugged Remote

7.1 Operation

The Rugged Remote is paired to a single ScaleCore RF device and replicates the front panel buttons. Slight variations between each device's buttons will result in different operation in the Rugged Remote. See [Table 7-1](#) for corresponding buttons for the Rugged Remote and the connected device.



NOTE: The Rugged Remote can only be paired to a single ScaleCore device. Reprogramming to configure communication to a different ScaleCore device can only be performed at the factory or with the purchase of additional RF modems.

Rugged Remote	MSI-8004HD	Description
		Power
		Zero
		Function 1
		Function 2

Table 7-1. Corresponding Buttons

7.1.1 Power

The Rugged Remote can be enabled to turn on and off the ScaleCore device it is paired remotely. The hold function must be enabled in the MSI-8004HD ([Section 6.3 on page 54](#)).



NOTE: *The Hold feature causes the device's modem to stay on and continuously draw from the battery, even when the device is turned off, resulting in decreased battery life.*

7.1.2 Zero

Press  to remove small deviations in zero when the MSI-8004HD is unloaded ([Section 3.2 on page 28](#)).

This key is not programmable.

7.1.3 Programmable Function Keys

Tare/F1 and FCN/F2 (pictures of buttons) are programmable in the MSI-8004HD. Function 1 is defaulted to Peak hold and Function 2 is defaulted to Test in the MSI-8004HD. See [Section 4.3 on page 34](#) to configure the MSI-8004HD function keys for Rugged Remote operation.

7.2 Conflict and Jamming Considerations

It is important to understand that only one transmitter at a time can be activated within a reception area. While the transmitted signal consists of encoded digital data, only one carrier of any frequency can occupy airspace without conflict at any given time. This is not to say that there cannot be multiple remote controls for the unit, but rather that two cannot be used simultaneously.

8.0 Troubleshooting and Maintenance

8.1 Troubleshooting



Problem	Possible Cause	Solution
The display is blank when the power button is pressed	Discharged battery	Recharge the battery
	Defective battery	Replace the battery (factory replacement only)
	Defective switch or circuit board	Requires authorized service
The display does not function properly/ Front panel buttons do not function normally/scale/Dyna-Link will not turn off	Improperly loaded software	Reinstall the software
	Faulty circuit board	Requires authorized service
	Loose connectors	Requires authorized service
Does not respond to weight/tension changes	Out of calibration	Calibrate the unit
	Faulty load cell	Replace the load cell
	Load cell connector	Check connectors and wires
The display over ranges below 100% of capacity	Tared weight/tension is added to load to determine overload point	Return to gross tension mode
	Zero requires adjustment	Rezero the scale
	Too much weight/tension has been zeroed	Rezero the scale
The display drifts	AZM (Auto 0) is turned off	Turn AZM on
	Rapid temperature changes such as moving the scale from indoors to outdoors	Wait until the scale temperature has stabilized
The displayed weight/tension shows a large error	Scale not zeroed before load is lifted	Zero the scale with no load attached
	lb/kg units causing confusion	Select proper units
	Requires recalibration	Recalibrate the unit
The display reading is not stable	Excessive vibration	Increase filtering or increase <i>d</i> in Cal
	Excessive side loading	Improve load train symmetry
	Load cell faulty	Check load cell connections
The display toggles between Error and Load	Load exceeds capacity	Reduce tension immediately
	Faulty load cell or wiring	Check load cell and load cell wiring
The display toggles between Error and Button	A key is stuck or is being held down	Check switches for damage
Weight is on scale/Dyna-Link and RF Remote Display does not match	Units are not paired	See setting the RF Network address procedures
Lo Batt is blinking	The battery is low	Recharge the battery
Unit turns on, then immediately off	The battery is low	Recharge the battery
The load will not zero	The system not stable	Wait for stable symbol  to turn on Increase filtering for more stability
	Zero out of range	Zero range might be limited; Reduce the tension or use Tare instead
The load will not tare or total	The system not stable	Wait for the stable symbol  to turn on, or if in a mechanically noisy crane, increase the filtering or reduce the size of the scale increment <i>d</i> ; It is also possible to increase the motion window; Contact Rice Lake Weighing Systems if there is a problem getting the MSI-8004HD to zero, tare or total due to stability issues
Setpoint lights blink	Set point is enabled and the trigger point has been reached	Disable set points if they are not needed

Table 8-1. Troubleshooting

Problem	Possible Cause	Solution
The manual total does not work	A function key is not set to <i>total</i>	Set up Func1 or Func2 for <i>total</i>
	Tension must be stable	Increase filtering for more stability
The auto total does not work	Load must be stable	Wait for stable symbol  to turn on or increase filtering for more stability
	Load thresholds are not reached	Weight must exceed one percent of capacity for auto total to work; Weight must drop below 0.5% of capacity for additional weighments to register
RTC does not stay updated when power is off	Coin-cell battery may be spent	Replace coin-cell battery (Section 8.6 on page 71)

Table 8-1. Troubleshooting (Continued)

8.2 Error Codes

The ScaleCore Processor that is the heart of the MSI-8004HD Remote Display detects errors and generates error codes to aid in troubleshooting.



Error Code	Definition	Comment
LcOFF	LC Disabled	A Load cell was not enabled
2CAL	In Cal	The system is in calibration mode; Do not send commands unrelated to calibration
unCAL	Not Calibrated	System has not been calibrated
 Error LoAd	Overload	Tension/Weight exceeds set capacity +9 d or load cell is damaged or disconnected
 Error UndLd	Underloaded	Tension/weight is more than 20% negative or load cell is damaged or disconnected

Table 8-2. Error Codes

8.3 Service Counters



WARNING: Service Counters are important safety warning features for the MSI Brand of Rice Lake Weighing Systems and can only be reset at the factory by personnel from MSI. As part of the reset process, the service technician will perform a thorough load train inspection to ensure user safety and confirm that the product is ready to be returned for regular service.

Reference the *Crane Scale Safety and Periodic Maintenance Manual (PN 153105)* for proper loading techniques to improve the safety and longevity of your MSI Overhead Weighing Product. This publication is available for download at www.ricelake.com.

All Rice Lake RF linked scales/Dyna-Link 2 maintain two service counters for safety.

- The first counter (LFcnt) counts lifts above 25% of capacity
- The second counter (DLcnt) counts the number of times the RF linked scale has been overloaded

These counters warn the user to inspect the load train after a number of overloads or a long term frequency of high capacity lifts. Power up will be interrupted when the lift counter exceeds 16383 lifts or the overload counter exceeds 1023 overloads. Inspect the load train then push any key to continue operation.

This feature is only available on MSI-8004HD Software release 2.00 and above.

Access the Service Counters

Press **F2** CHAN and **PRINT** **F3** simultaneously, the following items display:

- *LFCnt* displays briefly, followed by the number of lifts
- *OLCnt* displays briefly, followed by the number of times the weight has exceeded capacity
- *E-CAL* and its value displays
- The unit returns to the weigh mode



NOTE: *F1* must be pressed, if the Test function is set to *F1*, it will need to be pressed twice.

Reference the Crane Scale Safety and Periodic Maintenance Manual, PN 153105, for proper loading techniques to improve the safety and longevity of the crane scale or Dyna-Link. This publication is available at www.ricelake.com and is included on the CD shipped with the MSI-8004HD.

8.4 Mechanical Dimensions

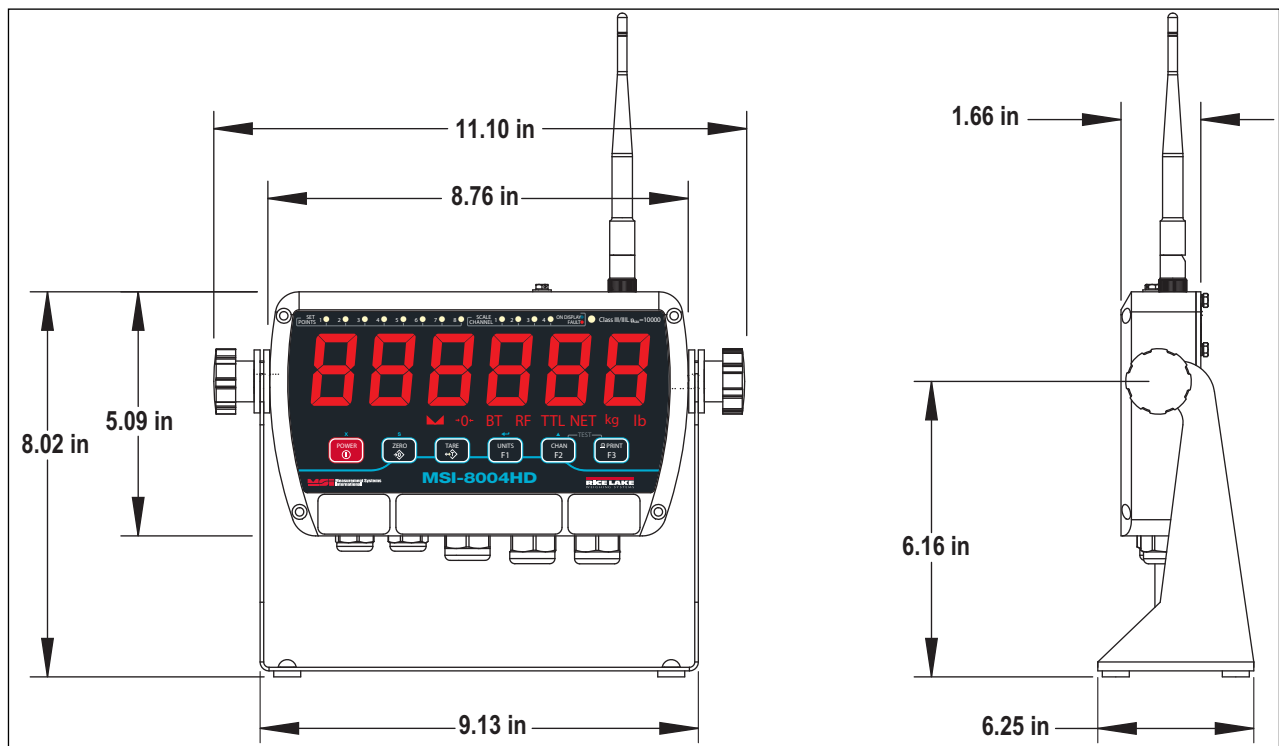

Figure 8-1. Mechanical Dimensions

8.5 Firmware Update

Updating firmware in the MSI-8004HD requires the following:

- DCE serial cable (PN 150964, or build per DCE cable schematic)
- PC with a terminal program (Teraterm Pro is recommended)
- USB to serial converter (if the PC does not have standard RS-232 serial ports)

Ensure the driver for the USB converter is properly installed, and that the terminal program is set up for the proper communications port.

The latest firmware code is available from the Rice Lake Weighing Systems technical support and can be emailed upon request. The firmware version is displayed when the MSI-8004HD is turned on as **01-04** (versions will vary). *MSI-8004HD* firmware updates do not require a recalibration of the connected scale. Consult the version release notes for information regarding the updated code.

1. Set up the terminal serial port to 8 data bits, no parity, 1 stop bit, 38400 BAUD, XON/XOFF (flow control).
2. Connect the MSI-8004HD to a PC using an appropriate serial cable and serial to USB adapter cable.
3. Establish a connection between the MSI-8004HD and PC through the terminal program (Teraterm).
4. Optional step: Test that there is a connection by typing {00FF01?}. If the connection is good the MSI-8004HD will respond with {000001r2;0;01E02;2011-07-08;11:05} or something similar.
5. On the terminal keyboard, type {ffff09=0199}. The MSI-8004HD shuts off.
6. Press  to turn the unit on again. The following menu should display.

MSI-8004HD Indicator SCALECORE2 BOOT LOADER Ver. xx-xx (c) Date, Time

- (u) Download and program application code
(the bootloader version may vary)
- (q) Query app code info
- (g) Execute app code
- (r) Refresh



NOTE: The bootloader version may vary.

7. Type **u**.
Terminal should display:
Send File NOW, or press ^ to abort:
8. Send the .prg file using the file send feature of the terminal program. The character # will tick away as the ScaleCore programs.
Send File NOW, or press ^ to abort:#####

Completed
9. After the file is received, the terminal displays **Completed**. Then the boot menu displays again.
MSI-8004HD Rice Lake MSI SCALECORE3 BOOT LOADER Ver. xx-xx (c) Date, Time
(u) Download and program application code
(the bootloader version may vary)
(q) Query app code info
(g) Execute app code
(r) Refresh

- Optional step: send **q** to check the program. The ScaleCore will respond with a message that details the 32b checksum, the product ID and version, and the Application Code version number in the following form:

```

Computed Signature 76F481D8
Received Signature 76F481D8
Product ID 07 MSI-8000 product family
Product Version ID 00 Optional features code
App Code Version xx-xx Firmware version number
    
```

↗ **32b CRC must match (76F481D8 is an example only)**

If the CRC Signature does not match, go back to step 4 and try again.

- Send an **r** to restore the boot menu.
 - MSI-8004HD Rice Lake MSI SCALECORE3 BOOT LOADER Ver. xx-xx (c) Date, Time
 - (u) Download and program application code
(your bootloader version may vary)
 - (q) Query app code info
 - (g) Execute app code
 - (r) Refresh
- Send a **g**. The MSI-8004HD should start.

8.6 Coin-Cell Battery Replacement

The Real Time Clock utilizes a CR2032 coin-cell battery to maintain time and date while the MSI-8004HD is disconnected from a power supply. If the MSI-8004HD no longer updates the time and date while the power is disconnected from a power supply, the battery may need to be replaced. Battery life is expected to be over 15 years with a fresh battery.

To replace the coin-cell battery, the circuit board must be detached from the mounting bracket.

- Disconnect the power cable from the power source.
- Remove the 8 hex screws on the back of the MSI-8004HD with a 1/4 in socket wrench.
- Remove the rear cover.
- Carefully remove the coin-cell battery from the battery holder with a small flathead screw driver.

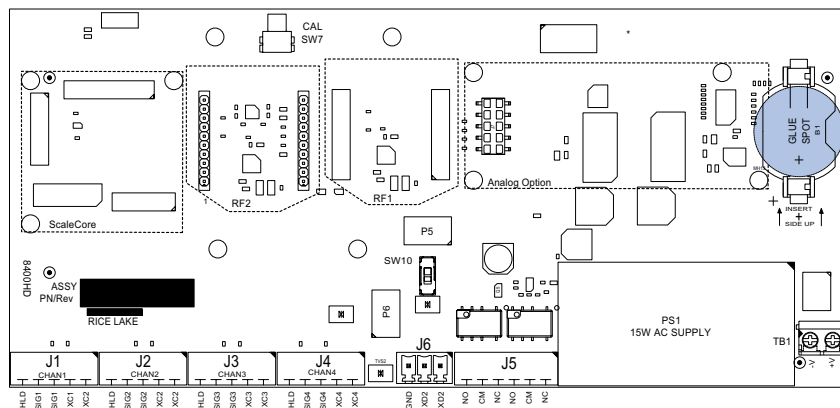

Figure 8-2. Coin-Cell Battery Location

IMPORTANT: Attempting to directly lift the coin-cell battery without a screwdriver could result in pulling the battery holder off of the circuit board. If the battery holder is pulled off of the circuit board, the entire board must be replaced.

- Replace the battery in the holder with the positive side facing up.
- Ensure that the gasket is seated directly in the channel.
- Replace the rear cover, ensuring that the gasket is seated directly in the channel.
- Torque the 8 hex screws on the back cover to 12-15 in-lbs.

9.0 Specifications

Power

90 to 267 VAC, 9 to 36 VDC, 18 to 72 VDC, 120 to 300 VDC

Excitation Voltage

4.8 V current limited and over-voltage protected

Functions

Peak hold, high resolution, total, view total, net/gross, units switching

Units

Pounds, kilograms

Channels

1, 2, 3, 4, TTL

RF Remote Channels

Up to four remote sensors, monitored individually, in pairs, or sum all (non-A/D version only) (when used with TranSend)

Service Counters

A/D version only

A/D Inputs

Two independent or summing load cell inputs

Relays

Two 5 V coil, 250 VAC, 5 A relays

Up to eight relays with optional Extended Relay Kit

Filtering

Off, Low, Hi-1, Hi-2

RF Radio Link

2.4 GHz 802.15.4, optional second channel for Serial RF, 802.11 Wi-Fi

RF Effective Range

Typically 100 to 300 ft, line of sight; for longer range consult factory

Communication Ports

Two RS-232 hard wired communication ports

Optional wired Ethernet

Annunciators

Stable, COZ, BT, RF, TTL, NET, kg, lb,

Channels: 1, 2, 3, 4, Setpoints 1 to 8

Display

Six-digit, 1.5 in (38 mm) LED display with red/green/orange coloring

Keys/Buttons

On/Off, Zero, Tare, Print and two user-defined keys

Operating Temperature

Operating: -40° to 140°F (-40° to 60°C)

Certified: 23° to 104°F (-5° to 40°C)

Rating/Material

NEMA Type 4, IP66 milled anodized aluminum with o-ring gaskets

Warranty

One-year limited

Approvals



NTEP

COC #17-036

Measurement
Canada
Approved

Measurement Canada

AM-6068



© Rice Lake Weighing Systems Content subject to change without notice.

230 W. Coleman St. • Rice Lake, WI 54868 • USA USA: 800-472-6703 • International: +1-715-234-9171